

minio
FURNITURE

Designs for spaces. Spaces to share, spaces to live.

Minio Furniture is a brand of Create Collections and, as it could not be otherwise, it has grown with the same DNA, design, quality and customer service.

We offer seating and table solutions designed, developed and tested, for all types of projects, both for homes and communities.

For over 40 years, we have been creating spaces where people can be, feel, and live. These are the values that define us.

Minio Furniture est une marque de Create Collections qui a été développée avec le même ADN, le même design, la même qualité et le même service au client.

Nous proposons des solutions d'assises et de tables conçues, développées et testées pour tous types de projets, aussi bien pour l'habitat que pour les collectivités.

Depuis plus de 40 ans nous créons des espaces, des espaces pour être, pour sentir, pour vivre. Ce sont les valeurs qui nous définissent.

Minio Furniture es una marca de Create Collections y como no podría ser de otra forma ha crecido con su mismo ADN, diseño, calidad y servicio al cliente.

Ofrecemos soluciones de asiento y mesas pensadas, desarrolladas y testadas, para todo tipo de proyectos, tanto para hogares como colectividades.

Llevamos más de 40 años creando espacios, espacios donde estar, donde sentir, donde vivir. Estos son los valores que nos definen.

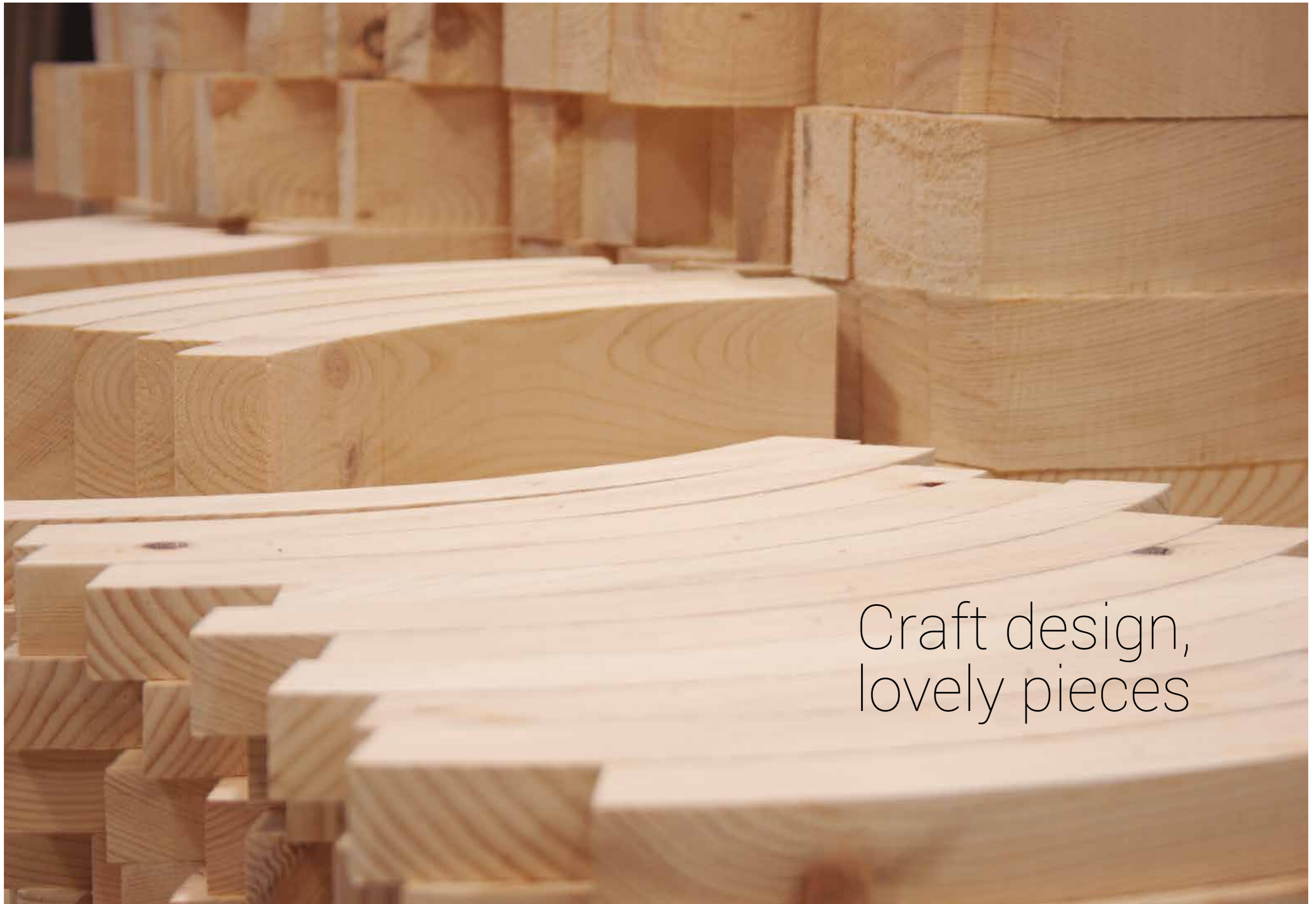

Craft design,
lovely pieces

INDEX

MINIO LAB



TABLE 1
7



TABLE 2
8



TABLE 3
9



FURNITURE
10



BAR COUNTER
11

ARMCHAIR & SOFA



BERN
15



FLUFO 85
27



FLUFO 142
27



GOI
29



MART
37

ARMCHAIR & SOFA



NAT 90
43



NAT 170
43



NONO
45



NONO FLUTTED
45



ODRI 59
48



ODRI 112
48

STOOL



ARC STOOL
13



BET STOOL
16



CLIP STOOL
18



COF STOOL
19



COF STOOL WI
19



DONA STOOL
21



KELA STOOL
32



LAF STOOL
33

BENCH



LESA BENCH
BASIC 35



LESA BENCH
CAPITONE 35



LESA B. P.
FLUTTED 35



UMAY BENCH
FLUTTED 60



UMAY B. PLINTH
FLUTTED 60

OUTDOOR CHAIR



PALMA CHAIR
ARM 53



PITA CHAIR
ARM 54

OUTDOOR A&S



PITA 85
54



PITA 160
54

INDOOR CHAIR



ARC CHAIR
13



BET CHAIR
16



BET CHAIR REP
16



COF CHAIR
19



COF CHAIR HL
19



COF CHAIR WI
19



DONA CHAIR
21



DONA CHAIR WI
21



DONA CHAIR
ARM 21



EDO CHAIR
23



ELIR CHAIR
24



ELIR CHAIR
LT ARM 24



EVE CHAIR
TAP AP 25



EVE CHAIR
WOOD AP 25



EVE CHAIR
STRING AP 25



GOT CHAIR
28



GOT CHAIR
HOLE 28



KA ARM
31



KELA CHAIR
32



KELA CHAIR ARM
32



LAF CHAIR
33



LAF CHAIR
ARM 33



MILA
38



MIN CHAIR
39



MIN CHAIR
ARM 39



MIN CHAIR NU
39



MIN CHAIR
ARM NU AP 39



NUR
46



NUZZ CHAIR
47



NUZZ CHAIR
ARM 47



ODRI CHAIR
48



ODRI CHAIR
ARM 48



PETAL CHAIR
51



PETAL CHAIR ARM
51



ROUND
56



TIS CHAIR
59



TIS CHAIR RES
59



VAS ARM
62



ZEN
63

POUFF



BALL POUFF
14



SAG POUFF
FOOT 58



SAG POUFF
58

TABLE TOP INDOOR



SOLID OAK PLAIN
65

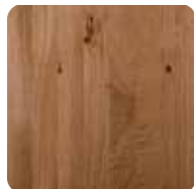

SOLID OAK BRUSH
67

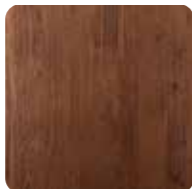

SOLID OAK USED
69



SOLID PINE USED
71

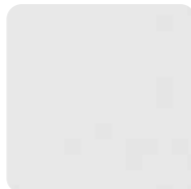

COVER CERAMIC
72



COVER MARBLE
74



H-TRES
77



MULTILAM LISO
78

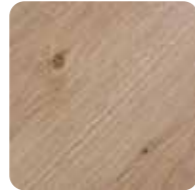

MULTILAM RUSTIK
79



MULTILAM OLIVATO
80



ALNO H72
82



ALNO BIG H72
82



ALNO HIGH H107
82



BECKA H72
84



BECKA REC. H72
84



BECKA HIGH H107
84



FOUR H72
86



FOUR REC. H72
86



FOUR HIGH 107
86



HEXA H72
88



HEXA REC. H72
88



HEXA HIGH H107
88



LASSO H72
90



LINE SQ. LOW
H42 91



LINE SQUARE
H72 91



LINE SQ. HIGH
H107 91



LINE SQ. BIG
H72 91



LINE ROUND LOW
H42 91



LINE ROUND H72
91



LINE ROUND
HIGH H107 91



LINE ROUND BIG
H72 91



LINE REC.
LOW H42 91



LINE REC. H72
91



LINE REC. HIGH
H107 91

TABLE BASE INDOOR



NODO H72
93



POLO SQ. H72
94



POLO REC. H72
94



POLO BIG H72
94



POLO HIGH H107
94



TRIO H72
96



TRIO HIGH H107
96

TABLE TOP OUTDOOR



MULTILAM MITE
OUTDOOR 98

TABLE BASE OUTDOOR



S200
99



S300
99



S400
100



S800
100



S900
101

MINIO FINISHES



MINIO SEAT
FINISHES 102

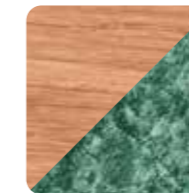

MINIO TABLE
FINISHES 103-105

TABLE BASE INDOOR

MINIO
LAB

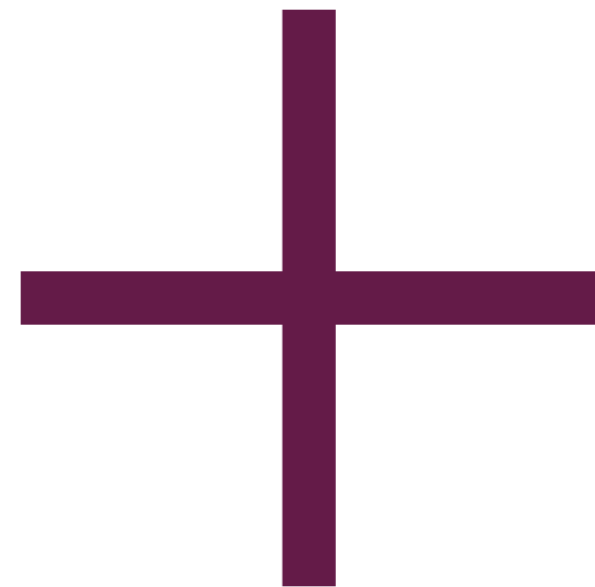



Table 1

Minio Lab #1

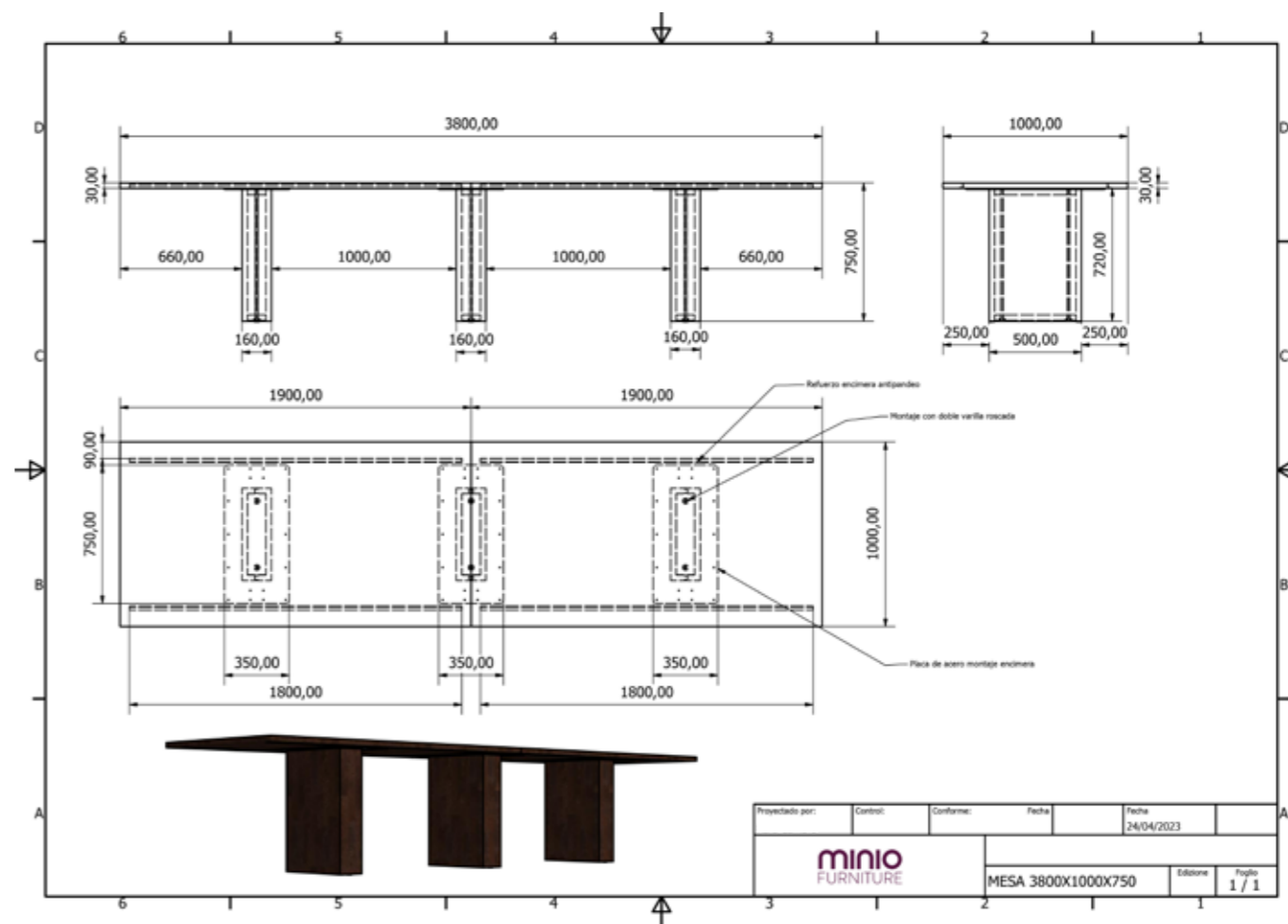



Table 2

Minio Lab #2

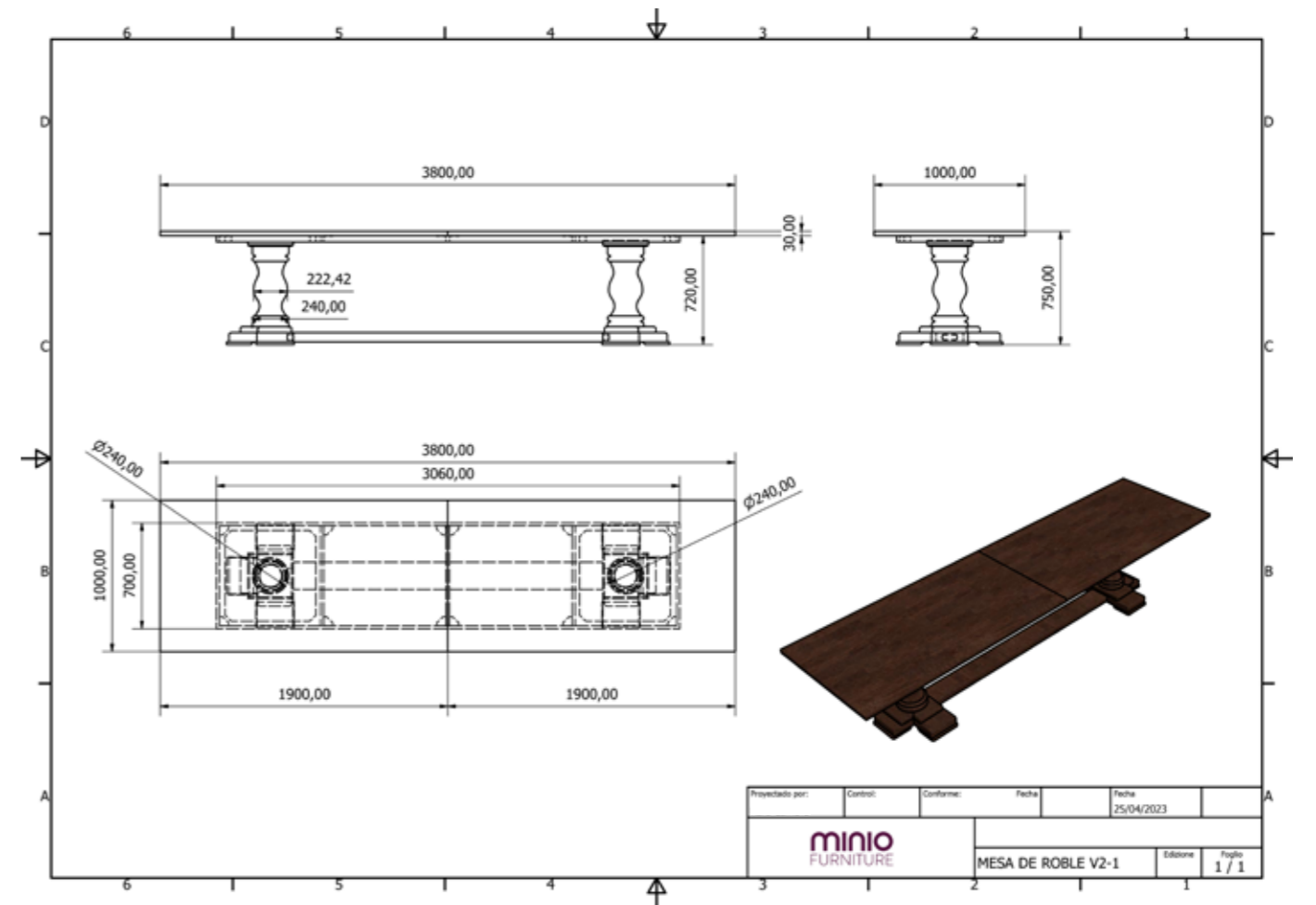
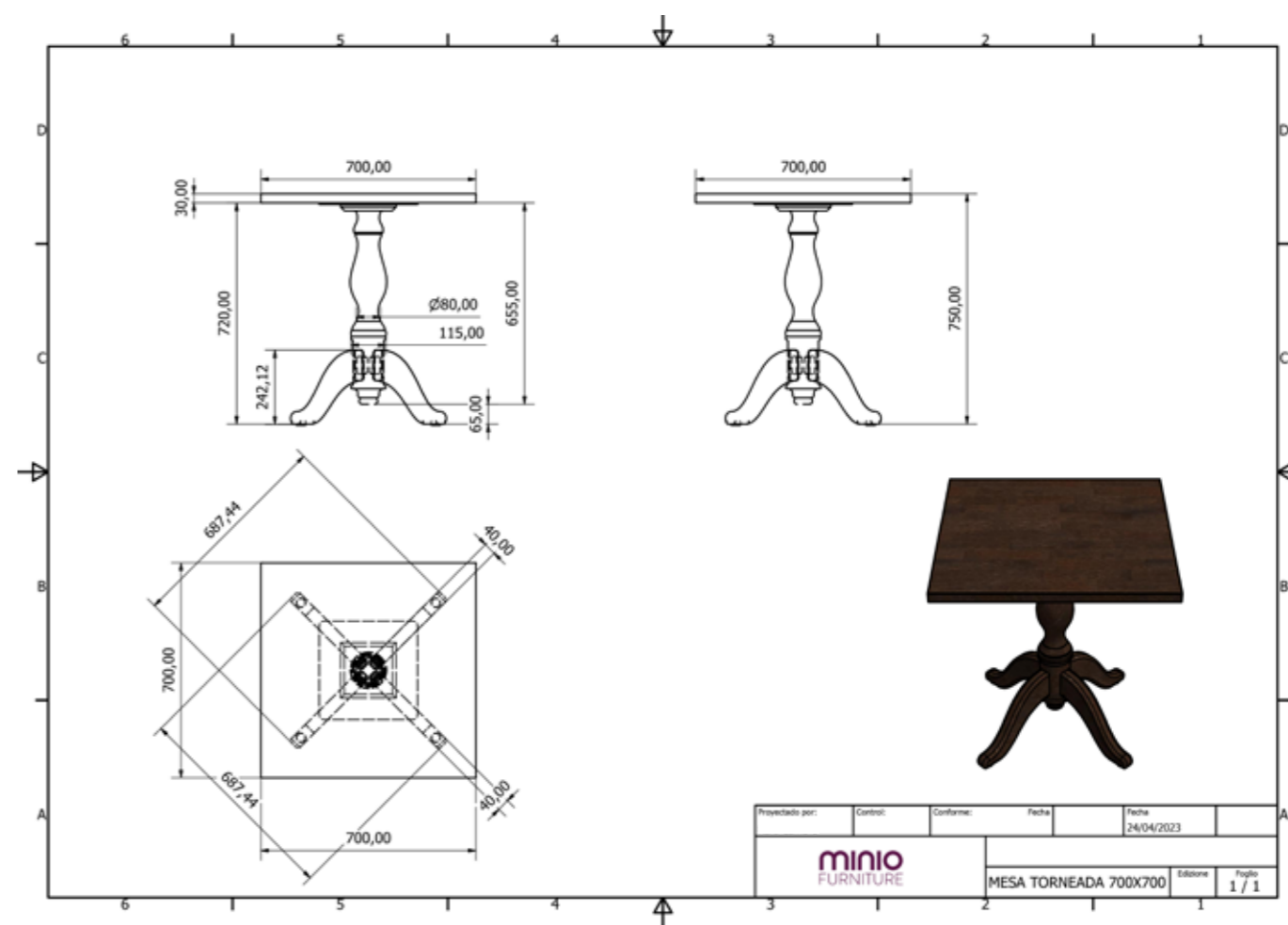



Table 3

Minio Lab #3



Mueble para platos y television con la trasera tapizada. | Meuble de rangement + TV avec l'arrière tapissé. | Plate and TV cabinet with upholstered back.

Furniture

Minio Lab #4

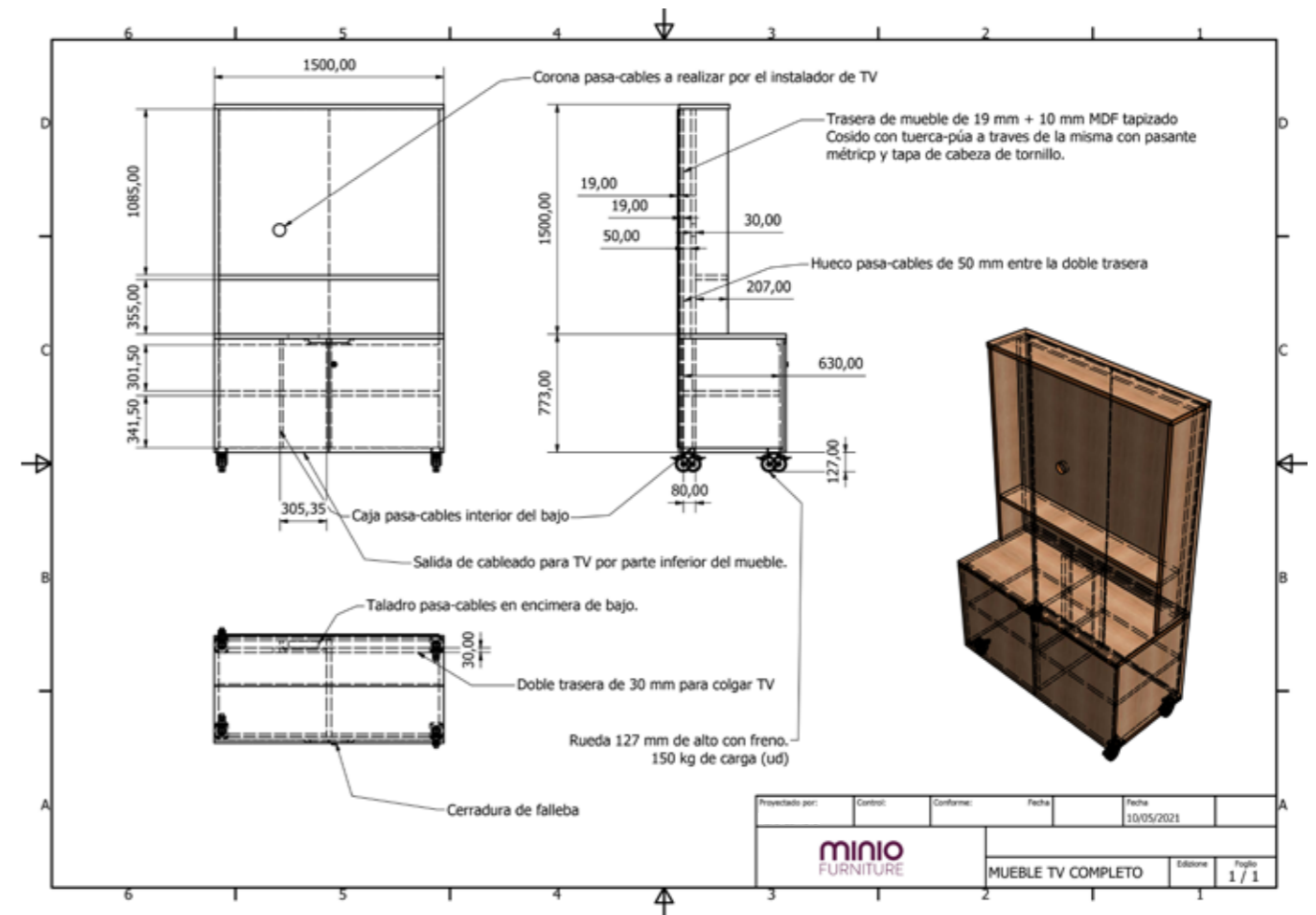
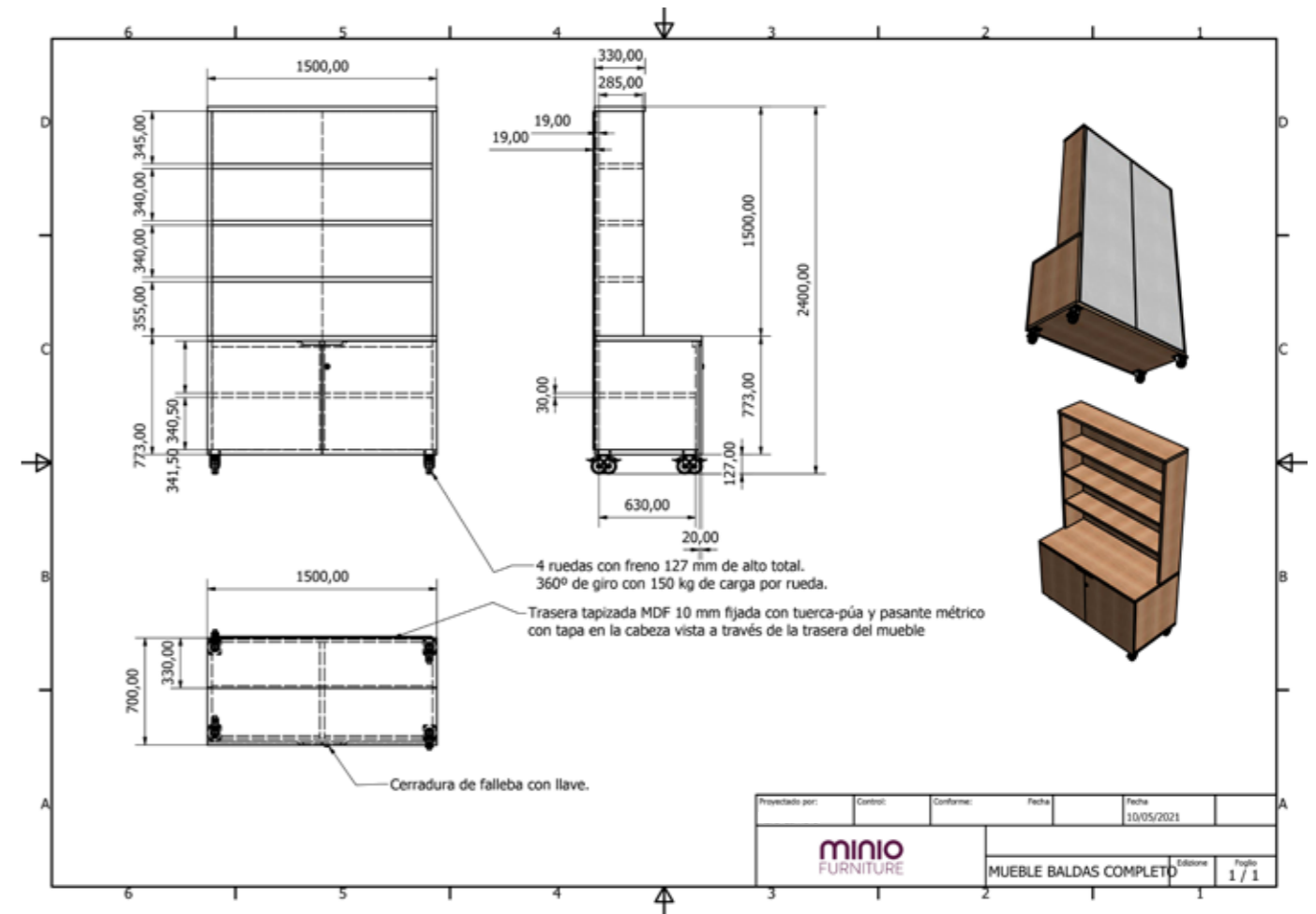

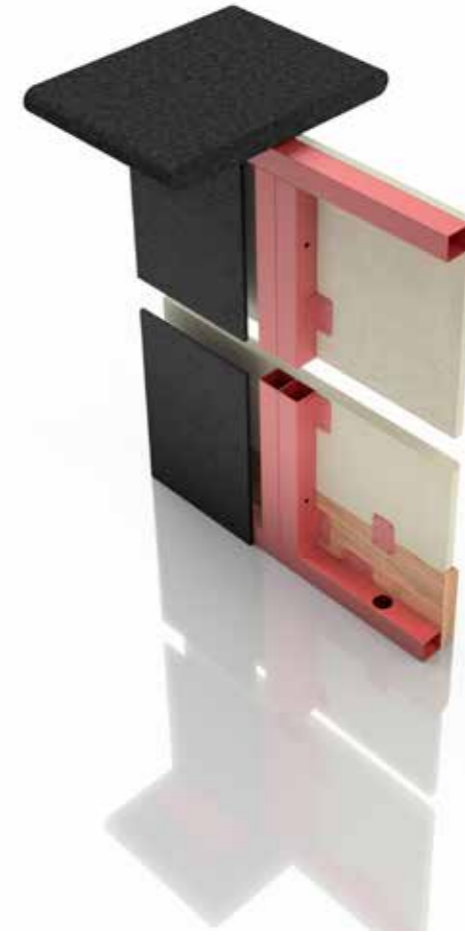

Bar Counter

Minio Lab #5

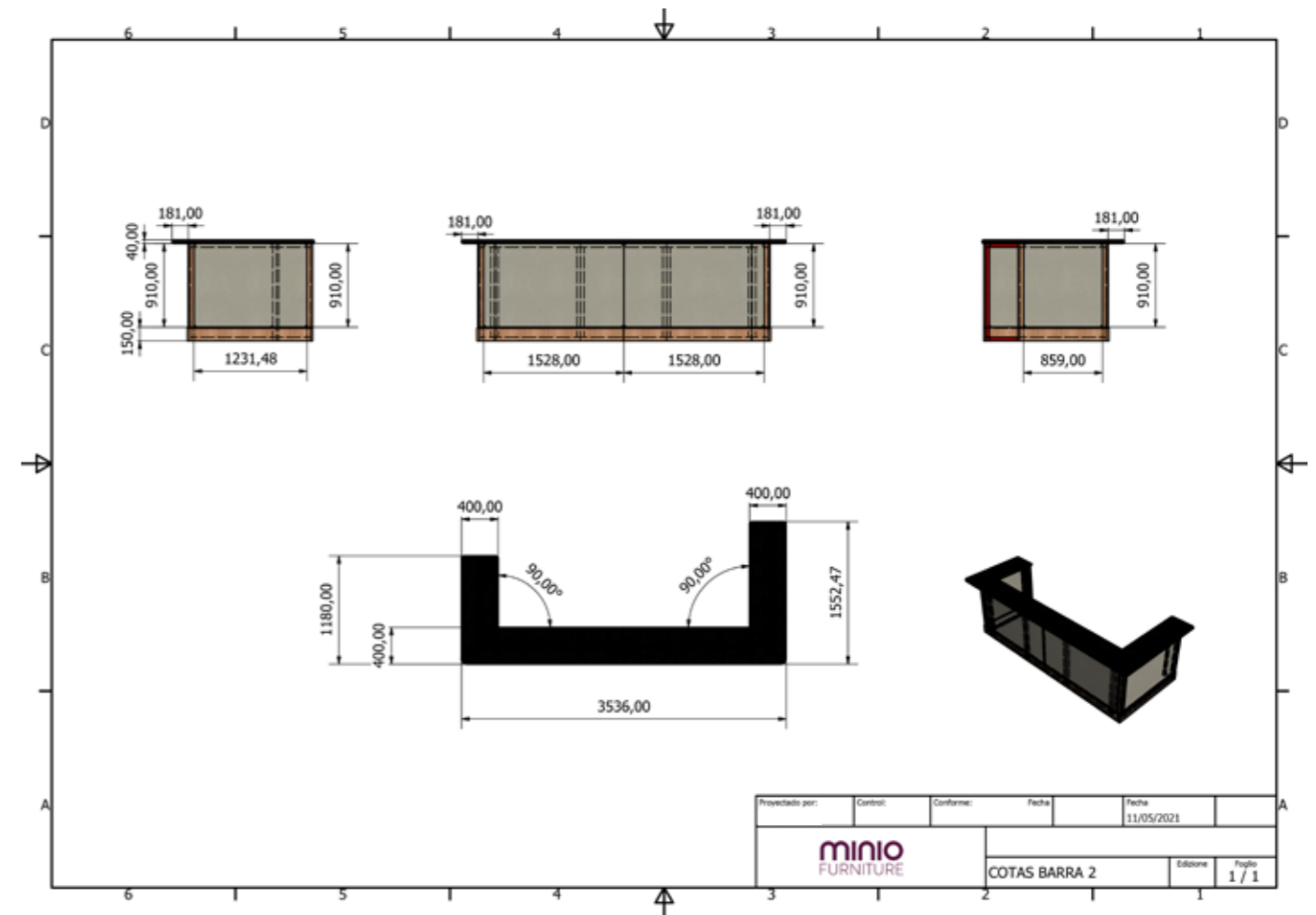

MINIO
SEAT

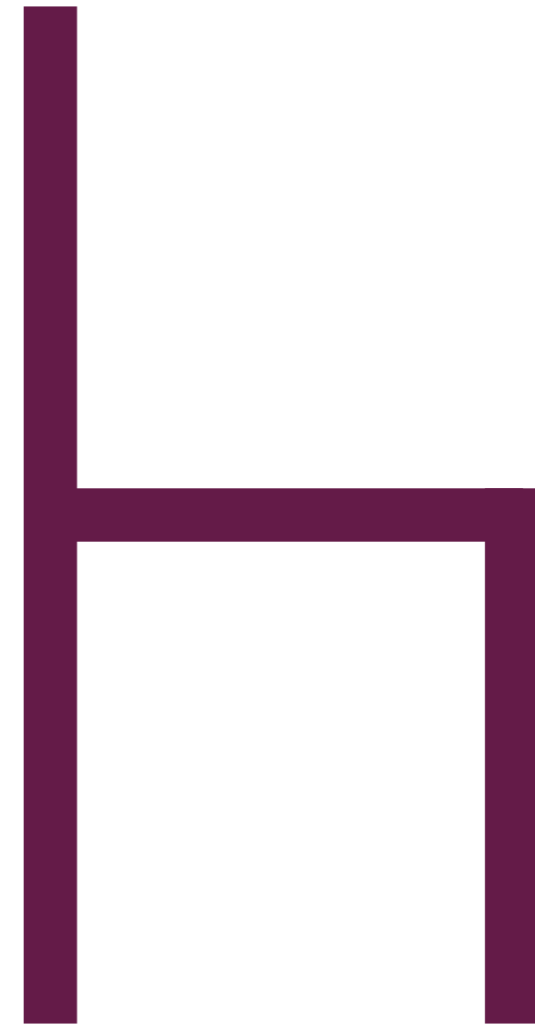

Arc is a collection that stands out for its careful lines. The backrest is shaped like an arc, and embraces the seat with great delicacy. The ends of this arc are culminated by wooden details that make this model unique. Its wooden structure matches the lines of the collection, drawing soft and subtle shapes that accommodate the upholstered elements. The design has a singular appearance, becoming the protagonist in any space it inhabits.



Arc

Upholstered

Beech / Hêtre / Haya

Arc Chair

Arc Stool

	50 cm 19,7"
	59 cm 23,2"
	81 cm 31,9"
	51 cm 20,1"

	50 cm 19,7"
	59 cm 23,2"
	112 cm 44,1"
	81 cm 31,9"



Arc Chair



Arc Stool

The Ball pouff is a complement to any seating space. There are many added values, from a seat to a side table to a footrest, these simple elements play a very important role in functional sets in the decoration of a Hospitality space.

Ball Pouff

Upholstered

Beech / Hêtre / Haya



∅ 49 cm | 19,3"

H 44,5 cm | 17,5"



The Bern Collection has a design inspired by the 1950's design style. This is a comfortable model and the first one, at Minio, in which injectable foam was used.



Bern

Upholstered

Beech / Hêtre / Haya



77 cm | 30,3"

84 cm | 33"

110 cm | 43,3"

45,5 cm | 17,9"

62 cm | 24,4"



Inspired by the Scandinavian design style, the Bet collection is composed by chairs and bar stools entirely designed in wood, with the possibility of having the seat and armrest upholstered. This timeless design is a must-have in any interior design project.

Bet

Upholstered

Beech / Hêtre / Haya

Bet Chair

	Icon	cm	inch
□	👤	54	21,3"
□	👤	55,5	21,8"
□	👤	73,5	28,9"
□	👤	47,5	18,7"
□	👤	73,5	28,9"

Bet Chair Rep

	Icon	cm	inch
□	👤	55	21,6"
□	👤	56,5	22,2"
□	👤	80	31,5"
□	👤	55,5	21,8"
□	👤	75,5	29,7"

Bet Stool

	Icon	cm	inch
□	👤	53,5	21,1"
□	👤	57,5	22,6"
□	👤	102	40,1"
□	👤	78,5	30,9"
□	👤	103,5	40,7"





Bet Chair

Bet Chair Rep



Bet Stool



Bet Chair

Bet Chair Rep

The Clip Collection was designed to complement the need to frame a practical and comfortable product, however, with a modern and striking design, which is the perfect portrait of the Japanese method of organization, Marie Kondo. The Clip Stool has an upholstered seat, with a wooden structure and stainless steel protection.

Clip Stool

Upholstered

Beech / Hêtre / Haya



37 cm | 14,6"

37 cm | 14,6"

80,5 cm | 31,7"



The Cof Collection, as the name implies, was inspired by coffee beans. With soft, sinuous lines, this model is captivating, discreetly inviting you to sit down. In this design, different materials were used, such as cotton, natural cane and nautical rope, which resulted in a diverse collection with an image and design of refinement. Cof conveys a strong personality, while also being versatile enough to be integrated into any interior design, regardless of the style. All these models are available as a chair and a bar stool, with the option of customizing the back as well as the fabric of the seat.

Cof

Upholstered

Ash / Frêne / Fresno

Cof Chair



□	55 cm 21,6"
┌	54 cm 21,3"
└	84 cm 33,1"
└	52 cm 20,5"

Cof Chair HL



□	54 cm 21,3"
┌	54 cm 21,3"
└	83 cm 32,7"
└	52 cm 20,5"

Cof Chair WI



□	54 cm 21,3"
┌	54 cm 21,3"
└	83 cm 32,7"
└	52 cm 20,5"

Cof Stool



□	55 cm 21,6"
┌	55 cm 21,6"
└	106 cm 41,7"
└	78 cm 30,7"

Cof Stool WI



□	55 cm 21,6"
┌	55 cm 21,6"
└	103 cm 40,5"
└	78 cm 30,7"

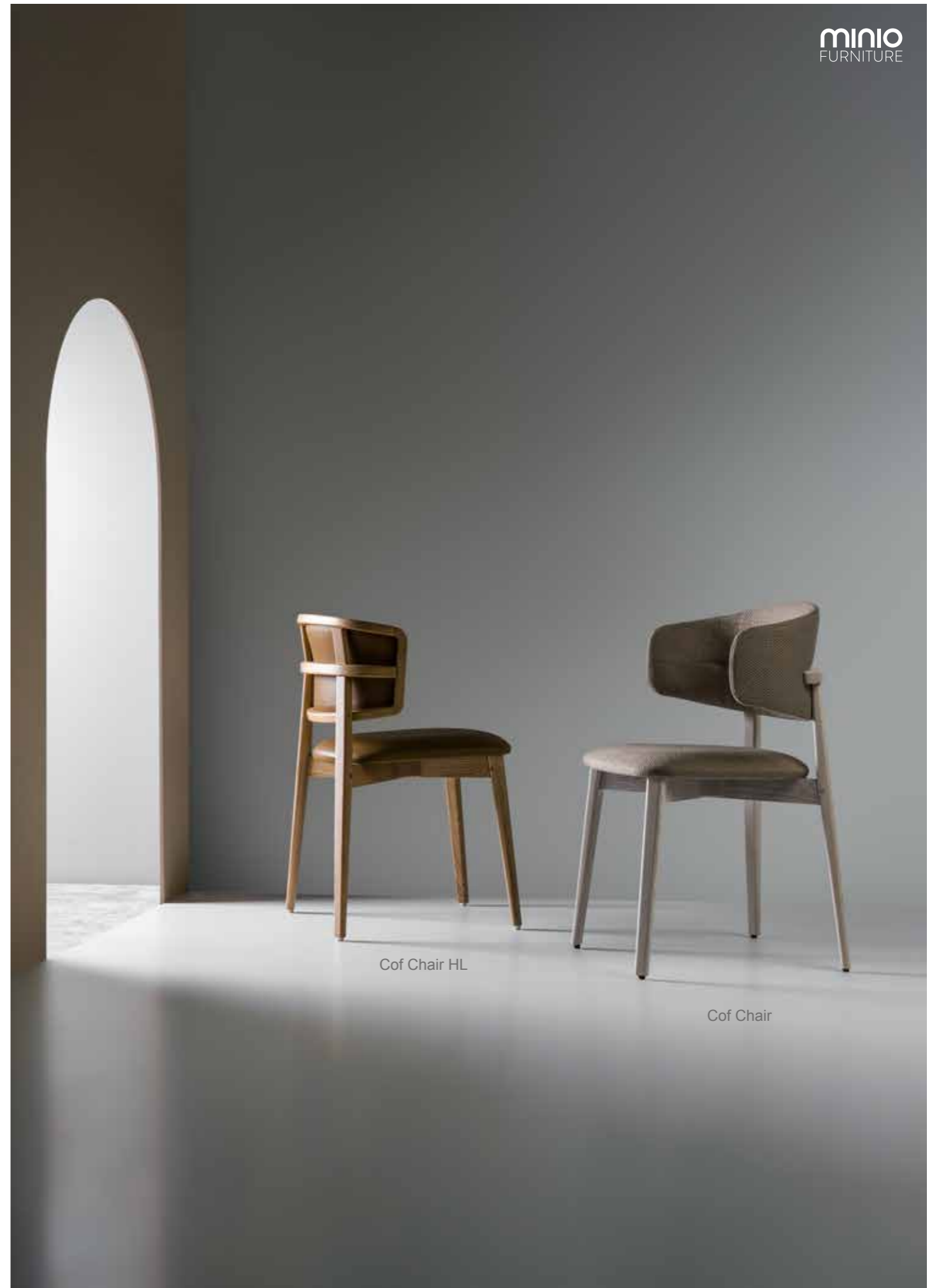

Cof Chair HL

Cof Chair



Cof Chair WI



Cof Chair HL



Cof Stool

Cof Stool WI



Cof Chair



Cof Chair HL







The Dona Collection is the perfect balance between the 1950s design and Nordic style. This equation resulted in the perfect symbiosis between fine and elegant lines that the region of Northern Europe conveys. The collection includes the chair, arm-chair and bar stool versions. Each typology can be produced entirely in wood or with upholstery, both on the seat and on the back. To complement the collection, there is also an option with natural cane.

Dona

Upholstered

Beech / Hêtre / Haya





Dona Chair

	
 49 cm 19,3"	
 51 cm 20,1"	
 86 cm 33,9"	
 50,5 cm 19,9"	





Dona Chair Arm

	
 64,5 cm 25,4"	
 58 cm 22,8"	
 86 cm 33,9"	
 50 cm 19,7"	
 69 cm 27,2"	

Dona Stool

	
 48 cm 18,9"	
 53,5 cm 21,1"	
 107,5 cm 42,3"	
 81 cm 31,9"	

Dona Chair WI

	
 49 cm 19,3"	
 51 cm 20,1"	
 86 cm 33,9"	
 50 cm 19,7"	





Dona Chair



Dona Chair Arm



Dona Stool



Dona Chair WI

The Edo Collection has a structure made of solid wood, where the seat fits into the perfectly curved plywood backrest. Circular shapes result in elegant lines, which provide the sensation of movement and lightness. This collection is available in different combinations, from the model made of wood and with an upholstered seat, to the fully upholstered version.



Edo

Upholstered

Ash / Frêne / Fresno

Edo Chair



- 46 cm | 18,1"
- 57,5 cm | 22,6"
- 87 cm | 34,2"
- 47,5 cm | 18,7"



Elir, a timeless collection where comfort meets design. With curved but simple lines, the Elicia Collection is one of Minio's best sellers and is composed by chairs and bar stools, which incorporate a famous character in the interior design projects where they are inserted. This is the ideal product to include both in residential and in hotel and restaurant projects.



Elir

Upholstered

Beech / Hêtre / Haya

Elir Chair

Elir Chair Arm

Elir Chair LT

Elir Chair LT Arm

	54,5 cm 21,4"
	63 cm 24,8"
	84 cm 33,1"
	50 cm 19,7"

	57 cm 22,4"
	63 cm 24,8"
	84 cm 33,1"
	50 cm 19,7"
	70 cm 27,5"

	54,5 cm 21,4"
	63 cm 24,8"
	84 cm 33,1"
	50 cm 19,7"
	70 cm 27,5"

	57 cm 22,4"
	63 cm 24,8"
	84 cm 33,1"
	50 cm 19,7"
	70 cm 27,5"



Elir Chair LT Arm

Elir Chair

The Eve Collection was inspired by Scandinavian design and with a simple linear structure. Even chairs are stackable and have a nautical rope or upholstered backrest, being thus, a versatile collection. Despite its simplicity, the Eve collection has a curved back and, considering the entire structure, it is a technically complex model, however, it does not transmit it, but rather lightness and comfort.

Eve















Upholstered

Beech / Hêtre / Haya

Eve Chair Tap AP

Eve Chair Wood AP

Eve Chair String AP

		
 46 cm 18,1"	 58 cm 22,8"	 51 cm 20,1"
 57,5 cm 22,6"	 58 cm 22,8"	 58 cm 22,8"
 87 cm 34,3"	 78 cm 30,7"	 78 cm 30,7"
 47,5 cm 18,7"	 50 cm 19,7"	 49 cm 19,3"

* Stackable 4u. max. / Empilable 4u. max. / Apilable 4u.max.

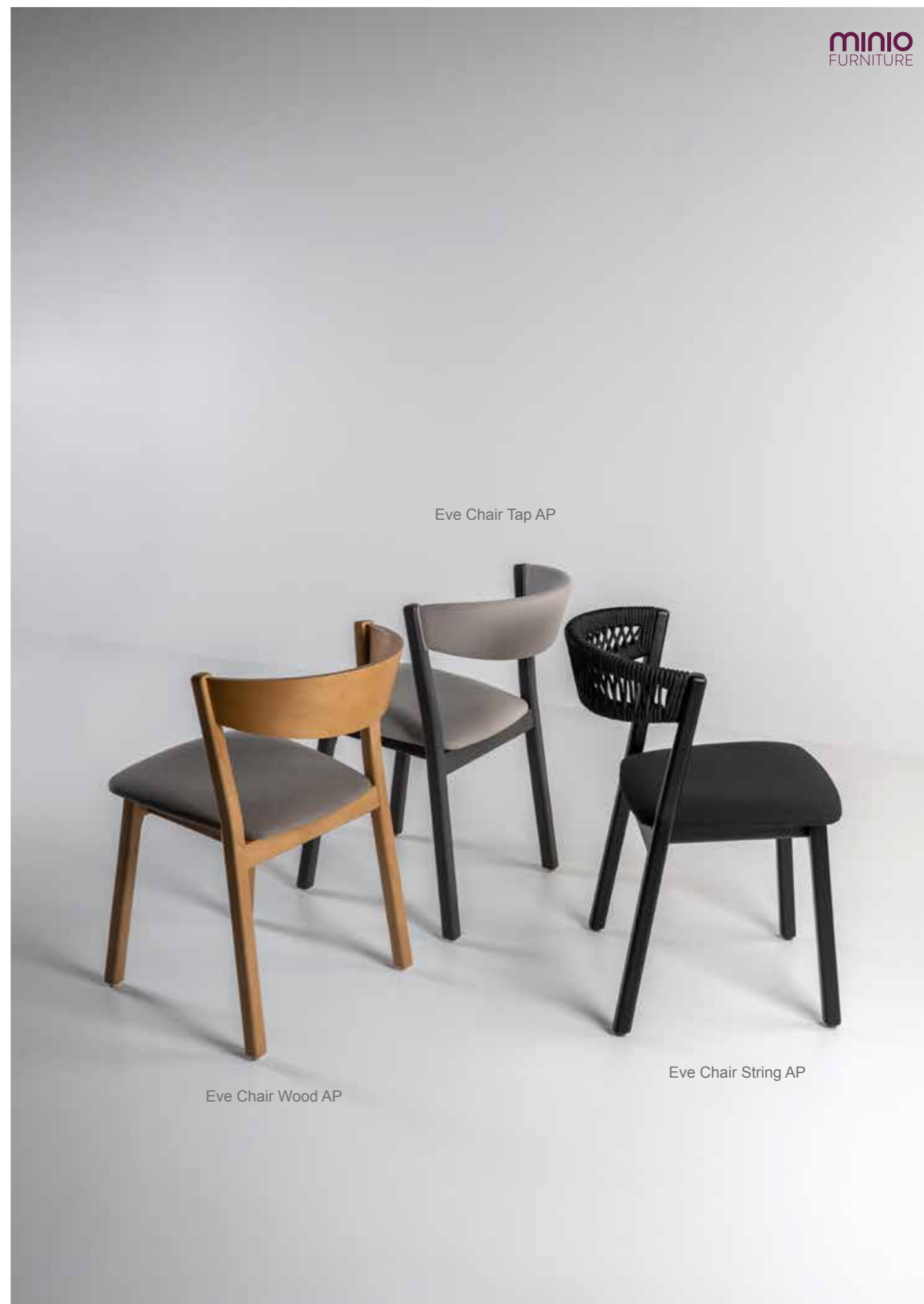



Eve Chair Tap AP



Eve Chair Wood AP



Eve Chair String AP



The Fluvo collection is synonymous with comfort. A young, current line, with an emphasis on upholstery and blunt shapes, under a metal base. The concept is based on the cushions and the comfort they provide.

Fluvo

Upholstered

Black metal foot / Pied en métal noir / Pie metálico negro

Fluvo 85



85 cm 33,5"
88 cm 34,6"
84,5 cm 33,3"
45 cm 17,7"
69 cm 27,2"

Fluvo 142



142 cm 55,9"
88 cm 34,6"
84,5 cm 33,3"
45 cm 17,7"
69 cm 27,2"





Flufo 85







Flufo 142

Goi Lounge is a bold model outlined by smooth and harmonious lines based on a classic and timeless style. Inviting relaxation, perfect for lounge areas, it is completely upholstered, with piping outlining its silhouette, and quite comfortable for a long relaxing time.

Goi

Upholstered

Beech / Hêtre / Haya

-  76 cm | 29,9"
-  88 cm | 34,6"
-  78 cm | 30,7"
-  44 cm | 17,3"
-  62 cm | 24,4"



A harmonious collection, where simplicity combines with the comfort and usability of the products. Got is a collection with elegant design lines that convey a welcoming feeling. This is an integrated collection that includes upholstered chairs and armchairs, with brass end caps, as well as dining tables and side tables. Got allows you to decorate an entire space.



Got





Upholstered





Beech / Hêtre / Haya





Got Chair

Got Chair Hole

Got Chair Hole LT

	48,5 cm 19,1"
	60 cm 23,6"
	86 cm 33,8"
	48,5 cm 19,1"

	49 cm 19,3"
	60 cm 23,6"
	82 cm 32,3"
	48 cm 18,9"

	49 cm 19,3"
	58 cm 22,8"
	82,5 cm 32,5"
	49 cm 19,3"



Got Chair



Got Chair Hole



Got Chair Hole LT

Ka Arm was inspired by Scandinavian style and contemporary design. This model of chair, with a wooden structure and elegant curved lines, these models stand out for its beauty and appreciation of wood, maintaining a classic and timeless image. Ka Arm can be included in several decoration projects, from residential interiors, hotels and restaurants.

Ka Arm

Upholstered

Ash / Frêne / Fresno



- 63 cm | 24,8"
- 58 cm | 22,8"
- 79,5 cm | 31,3"
- 49,5 cm | 19,5"
- 72 cm | 28,3"



The Kela Collection has characteristics such as harmony, lightness and fierceness. This collection values comfort and the mid-century modern design style. It is one of Minio's attention catchers and exists in the form of a chair, armchair and bar stool.



Kela

Upholstered

Beech / Hêtre / Haya

Kela Chair

	53 cm 20,1"
	60,5 cm 23,8"
	81,5 cm 32,1"
	48 cm 18,9"

Kela Chair Arm

	54 cm 21,3"
	65 cm 25,6"
	82,5 cm 32,5"
	48 cm 18,9"
	64,5 cm 25,4"

Kela Stool

	53 cm 20,1"
	66 cm 26"
	105 cm 41,3"
	80,5 cm 31,7"



Kela Chair Arm

The Laf chair is a contemporary design piece characterized by the combination of raw materials: wood and leather. The chair has a solid wood structure that supports the suspended seat and artistic back, resulting in simple and light furniture pieces. In this authentic and light collection, you can find also the usual upholstered option.

Laf

Upholstered

Ash / Frêne / Fresno

Laf Chair



51 cm | 20,1"
55 cm | 21,6"
80 cm | 31,5"
47 cm | 18,5"

Laf Chair Arm



59 cm | 23,2"
58 cm | 22,8"
80 cm | 31,5"
43 cm | 16,9"
68 cm | 26,7"

Laf Chair Res



51 cm | 20,1"
55 cm | 21,6"
80 cm | 31,5"
47 cm | 18,5"

Laf Chair Res Arm



59 cm | 23,2"
58 cm | 22,8"
80 cm | 31,5"
47 cm | 18,5"
68 cm | 26,7"

Laf Chair Tap



51 cm | 20,1"
55 cm | 21,6"
80 cm | 31,5"
47 cm | 18,5"

Laf Chair Tap Arm



59 cm | 23,2"
58 cm | 22,8"
80 cm | 31,5"
47 cm | 18,5"
68 cm | 26,7"

Laf Stool



47 cm | 18,5"
52 cm | 20,5"
108 cm | 42,5"
83 cm | 32,7"





Laf Chair



Laf Chair Arm



Laf Chair Tap



Laf Chair Tap Arm



Laf Chair Res



Laf Chair Res Arm



Laf Stool

The Lesa Bench Collection consists of a geometric banquette that follows the Scandinavian design lines. This model can have different heights, which facilitates its integration in the different spaces where it can be inserted, whether restaurant or contract spaces.

Lesa Bench

Upholstered

Beech / Hêtre / Haya

Back black fabric / Arrière-dos en jaconas noir / contra respaldo tela negra

Lesa Bench Basic



□	120 cm 47,2"
┌	58 cm 22,8"
└	89 cm 35"
└	48 cm 18,9"

Lesa Bench Capitone



□	120 cm 47,2"
┌	58 cm 22,8"
└	89 cm 35"
└	48 cm 18,9"

Lesa Bench Fluted



□	120 cm 47,2"
┌	58 cm 22,8"
└	89 cm 35"
└	48 cm 18,9"

Lesa Bench Perimetral Basic



□	120 cm 47,2"
┌	58 cm 22,8"
└	89 cm 35"
└	48 cm 18,9"

Lesa Bench Perimetral Capitone



□	120 cm 47,2"
┌	58 cm 22,8"
└	89 cm 35"
└	48 cm 18,9"

Lesa Bench Perimetral Fluted



□	120 cm 47,2"
┌	58 cm 22,8"
└	89 cm 35"
└	48 cm 18,9"





Lesa Bench Basic



Lesa Bench Perimetral Basic



Lesa Bench Capitone



Lesa Bench Perimetral Capitone



Lesa Bench Fluted



Lesa Bench Perimetral Fluted

The Mart Collection consists of a model that has a differentiating detail: the shape of the back that is reminiscent of a tulip at the height of spring. In addition to its different shape, there are several seams on the seat and back that highlights the elegance of the model.



Mart

Upholstered

Beech / Hêtre / Haya



79 cm | 31,1"

76 cm | 29,9"

78 cm | 30,7"

48 cm | 18,9"







The Mila Chair is a wood-based model, with a unique back and upholstered seat. It reflects the revival of the design lines of the 1950s. It is a versatile chair that can fit into various styles of decoration, with restaurants projects being where it stands out the most.



Mila

Upholstered

Ash / Frêne / Fresno

-  46 cm | 18,1"
-  56 cm | 22"
-  80 cm | 31,5"
-  46,5 cm | 18,3"



The Min Collection is a collection of simple construction, in solid wood, but with a strong design component. The backrest and seat have a slight curvature, ensuring the models' ideal comfort. Sustainability, ergonomics and design were the motto for the development of this product family, which ranges from chairs and armchairs, to bar stools with and without backs, as well as stackable models.

Min



Upholstered

Ash / Frêne / Fresno





Min Chair

 51 cm 20,1"
 53 cm 20,9"
 83 cm 32,7"
 47 cm 18,5"

Min Chair Arm

 61 cm 24"
 56 cm 22"
 83 cm 32,7"
 47 cm 18,5"
 69 cm 27,2"

Min Stool

 47 cm 18,5"
 47 cm 18,5"
 81,5 cm 32,1"

Not Upholstered

Ash / Frêne / Fresno



Min Chair Nu

 51 cm 20,1"
 53 cm 20,9"
 83 cm 32,7"
 47 cm 18,5"





Min Chair Nu Ap*

 51 cm 20,1"
 53 cm 20,9"
 83 cm 32,7"
 47 cm 18,5"





Min Chair Arm Nu Ap*

 61 cm 24"
 56 cm 22"
 83 cm 32,7"
 47 cm 18,5"
 69 cm 27,2"

Min Nu High Stool

 44 cm 17,3"
 48 cm 18,9"
 110 cm 43,3"
 78 cm 30,7"

Min Nu Stool

 47 cm 18,5"
 47 cm 18,5"
 81,5 cm 32,1"

* Stackable 4u. max. / Empilable 4u. max. / Apilable 4u.max.



Min Chair

Min Chair Arm



Min Stool



Min Chair



Min Chair Arm



Min Chair Arm Nu Ap



Min Chair Nu



Min Chair Nu Ap



Min Chair Nu



Min Chair Arm
Min Chair Arm Nu Ap



Min Chair



Min Nu High Stool



Min Nu Stool

Min Nu High Stool

Min Stool

As the name implies, the Nat Collection is inspired by the characteristic shapes of the bamboo forest, the place where we can achieve a relaxed and serene state of mind, taking us back to our origins. This collection's details are achieved through the technique of specialized craftsmen, who manage to go from complex design to a harmonious and refined product. To these products, side cushions can be added if you want extra comfort or that work as a complement to the decoration of the space.

Nat

Upholstered

Beech / Hêtre / Haya

Nat 90



□	90 cm 35,4"
┌	77 cm 30,3"
└	77,5 cm 30,5"
┌	41 cm 16,1"
└	70 cm 27,5"

Nat 170



□	170 cm 66,9"
┌	77 cm 30,3"
└	77,5 cm 30,5"
┌	41 cm 16,1"
└	70 cm 27,5"

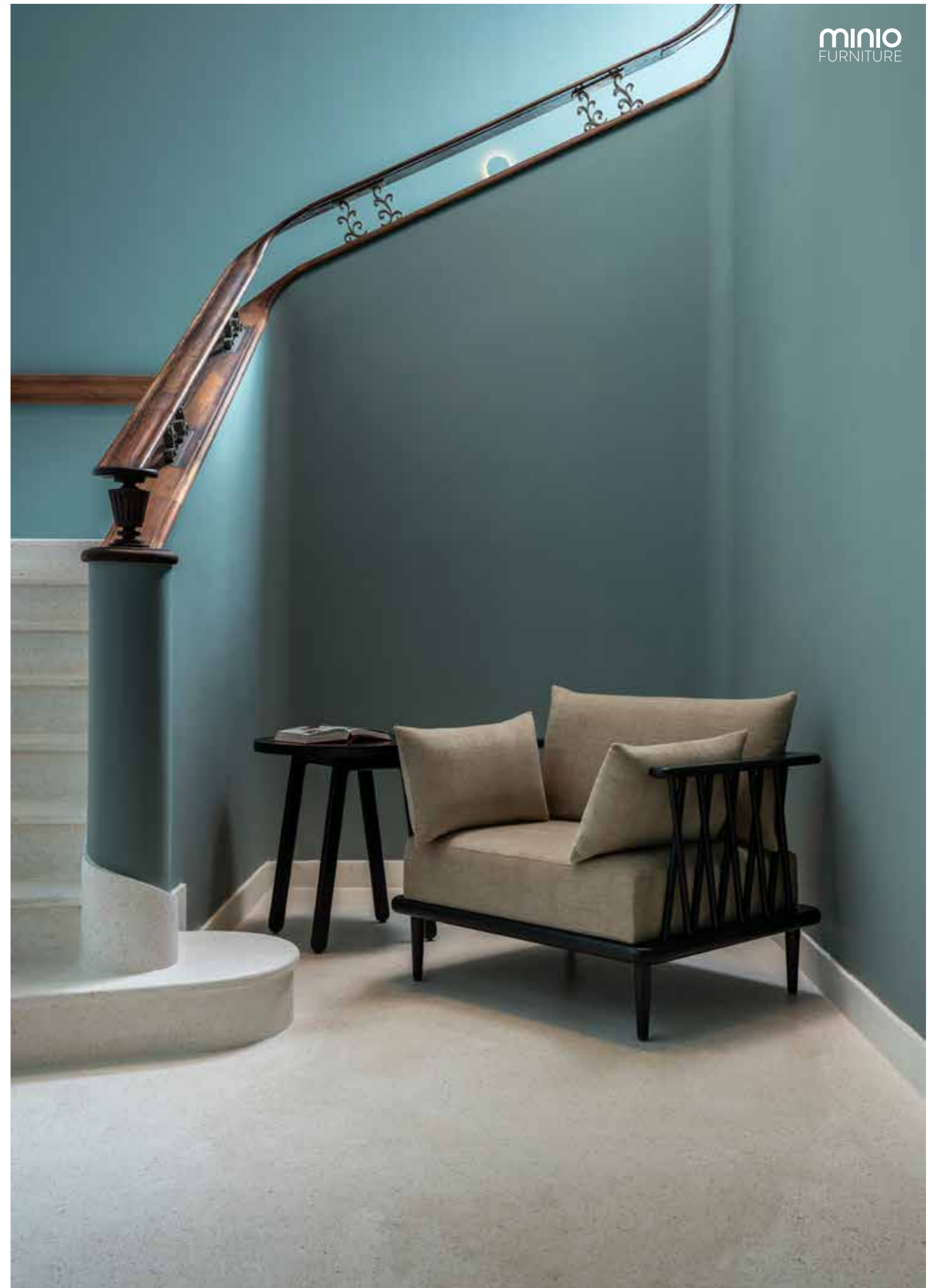



Nat 90



Nat 170

The models in the Nono Collection are inspired by the famous wingback chairs, characteristic of the mid-century design style. They are completely upholstered models, where the seams are an added value that contributes to the refinement of the product. One of the models has the inner back finished with the backstitching technique, a trend that is here to stay.

Nono

Upholstered

Beech / Hêtre / Haya

Nono



62,5 cm | 24,6"

67 cm | 26,4"

80 cm | 31,5"

44,5 cm | 17,5"

62,5 cm | 24,6"

Nono Fluted



62,5 cm | 24,6"

67 cm | 26,4"

80 cm | 31,5"

44,5 cm | 17,5"

62,5 cm | 24,6"



Nur is inspired by Scandinavian style and contemporary design. Consisting of two models of chairs, with a wooden structure and elegant curved lines, these models stand out for its beauty and appreciation of wood, maintaining a classic and timeless image.

Nur

Upholstered

Beech / Hêtre / Haya



60 cm | 23,6"

77 cm | 30,3"

57 cm | 22,4"

47 cm | 18,5"

71 cm | 27,9"



The Nuzz is the balance between design and confort, a collection of timeless beauty. The Nuzz Collection is the ideal choice for anyone looking to combine the refinement of these models with their residential, hotel or office project.



Nuzz

Upholstered

Beech / Hêtre / Haya

Nuzz Chair



51,5 cm | 20,3"

60 cm | 23,6"

82 cm | 32,3"

49,5 cm | 19,5"

Nuzz Chair Arm



52 cm | 20,5"

60 cm | 23,6"

82 cm | 32,3"

45 cm | 17,7"

64 cm | 25,2"



Nuzz Chair



Nuzz Chair Arm

The Odri collection is inspired by the vintage design style, thus creating chairs with curved and elegant lines. Being a fully upholstered collection, the Odri family values comfort.



Odri Chair

Odri Chair Arm

Odri

Upholstered

Beech / Hêtre / Haya

Odri Chair



- 55 cm | 21,6"
- └ 66 cm | 25,9"
- └ 86,5 cm | 34"
- └ 49 cm | 19,3"

Odri Chair Arm



- 55 cm | 21,6"
- └ 67 cm | 26,4"
- └ 78,5 cm | 30,9"
- └ 50 cm | 19,7"
- └ 67 cm | 26,4"

Odri Stool



- 50 cm | 19,7"
- └ 55,5 cm | 21,9"
- └ 109 cm | 42,9"
- └ 80 cm | 31,5"

Odri 59



- 59 cm | 23,2"
- └ 72 cm | 28,3"
- └ 77 cm | 30,3"
- └ 44 cm | 17,3"
- └ 77 cm | 30,3"

Odri 112



- 112 cm | 44,1"
- └ 82 cm | 32,3"
- └ 77 cm | 30,3"
- └ 44 cm | 17,3"
- └ 70 cm | 27,6"



Odri Chair

Odri Chair Arm



Odri 112



Odri 59



Odri Stool

The Osmo Lounge chair is a furniture design piece inspired by Oporto's city internationally known Porto wine, particularly the vats where the wine develop its flavor and aroma. The result is a volumous piece with a protective shape, elegantly designed. It's a versatile design piece that can fit in any modern interior decoration.

Osmo

Upholstered

Beech / Hêtre / Haya



- 79 cm | 31,1"
- 65,5 cm | 25,6"
- 68,5 cm | 26,9"
- 42 cm | 16,5"
- 67,5 cm | 26,6"



Petal is an elegant collection with simple yet contemporary chairs. With a clean style, preserving comfort, this collection is a "show stopper" in any ambiance, making it the perfect choice for hotel and restaurant projects. It is available in the chair, armchair, bar stool and sofa versions.

Petal

Upholstered

Beech / Hêtre / Haya

Petal Chair



□	50 cm 19,7"
└	59 cm 23,2"
└	85 cm 33,5"
└	49,5 cm 19,5"

Petal Chair Arm



□	62 cm 24,4"
└	62 cm 24,4"
└	84 cm 33,1"
└	50 cm 19,7"
└	67 cm 26,4"

Petal Stool



□	47 cm 18,5"
└	56,5 cm 22,2"
└	100,5 cm 39,6"
└	79,5 cm 31,3"

Petal 74



□	74 cm 29,1"
└	70 cm 27,6"
└	78 cm 30,7"
└	47 cm 18,5"
└	66 cm 26"

Petal 120



□	120 cm 47,2"
└	70 cm 27,6"
└	78 cm 30,7"
└	47 cm 18,5"
└	66 cm 26"





Petal 120



Petal Chair

Petal Stool



Petal 74



Petal Chair

Petal Chair Arm

Petal Stool

The Palma Outdoor Collection is inspired by the shapes that the boat sails assume when the wind blows. This was the image projected in the designer mind when he visited the natural park in the city of Valencia. Hence the slight curvature that the back of the chair assumes.



Palma

Upholstered

Iroko
Indoor-outdoor / intérieur-extérieur / Interior-exterior

Palma Chair Arm



- 65 cm | 25,6"
- 55 cm | 21,6"
- 83 cm | 32,7"
- 45 cm | 17,7"
- 67,5 cm | 26,6"



The Pita Collection has a graphic design shaped by rigorous geometry, like a theorem. With smooth lines and ideally designed for the outdoor environment, this is an elegant and comfortable collection that includes not only chairs and a sofa, but also a coffee table and a pouf. It is available in the chair, armchair, bar stool and sofa versions.

Pita

Upholstered

Iroko

Indoor-outdoor / intérieur-extérieur / Interior-exterior

Pita Chair Arm



□	57 cm 22,4"
└	64 cm 25,2"
└	88 cm 34,6"
└	51 cm 20,1"
└	67 cm 26,4"

Pitra 85



□	85 cm 33,5"
└	71,5 cm 28,1"
└	83,5 cm 32,9"
└	46,5 cm 18,3"
└	67 cm 26,4"

Pitra 160



□	160 cm 63"
└	71,5 cm 28,1"
└	83,5 cm 32,9"
└	46,5 cm 18,3"
└	67 cm 26,4"

* Available outdoor foam / Mousse extérieure disponible / Disponible con espuma para exteriores.





Pita Chair Arm



Pita 85
Armrest cushions included



Pita 160
Armrest cushions included

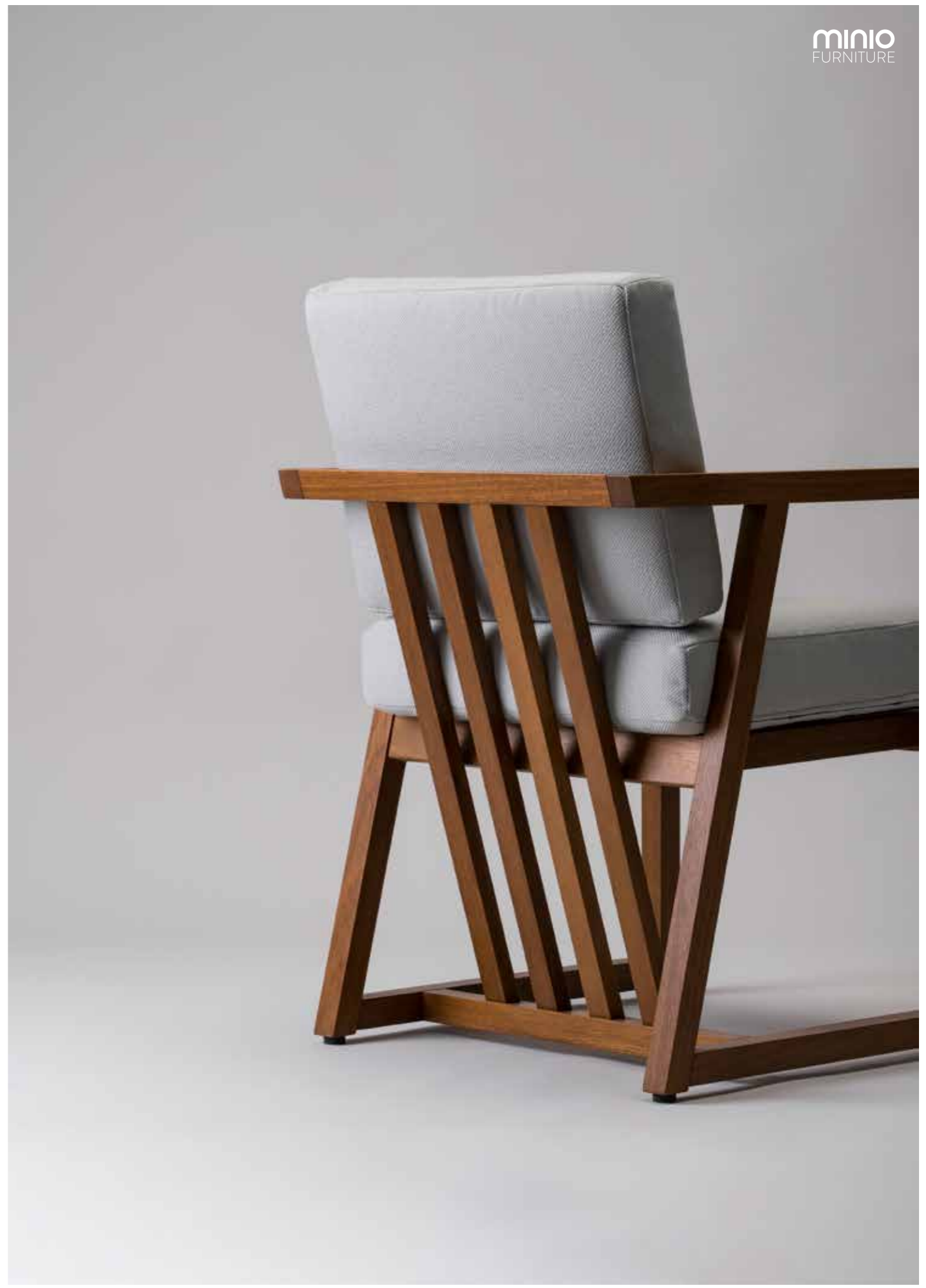

Pita Chair Arm

The Round Chair comprises a fully upholstered dining chair. Both the seat and the back are circular and fit into each other perfectly, being technically imperceptible. The Round Chair was developed considering the latest trends in terms of interior design and promises to be the statement piece of the project where it will be inserted.

Round

Upholstered

Beech / Hêtre / Haya



51 cm | 20,1"

56,5 cm | 22,2"

85 cm | 33,5"

48 cm | 18,7"

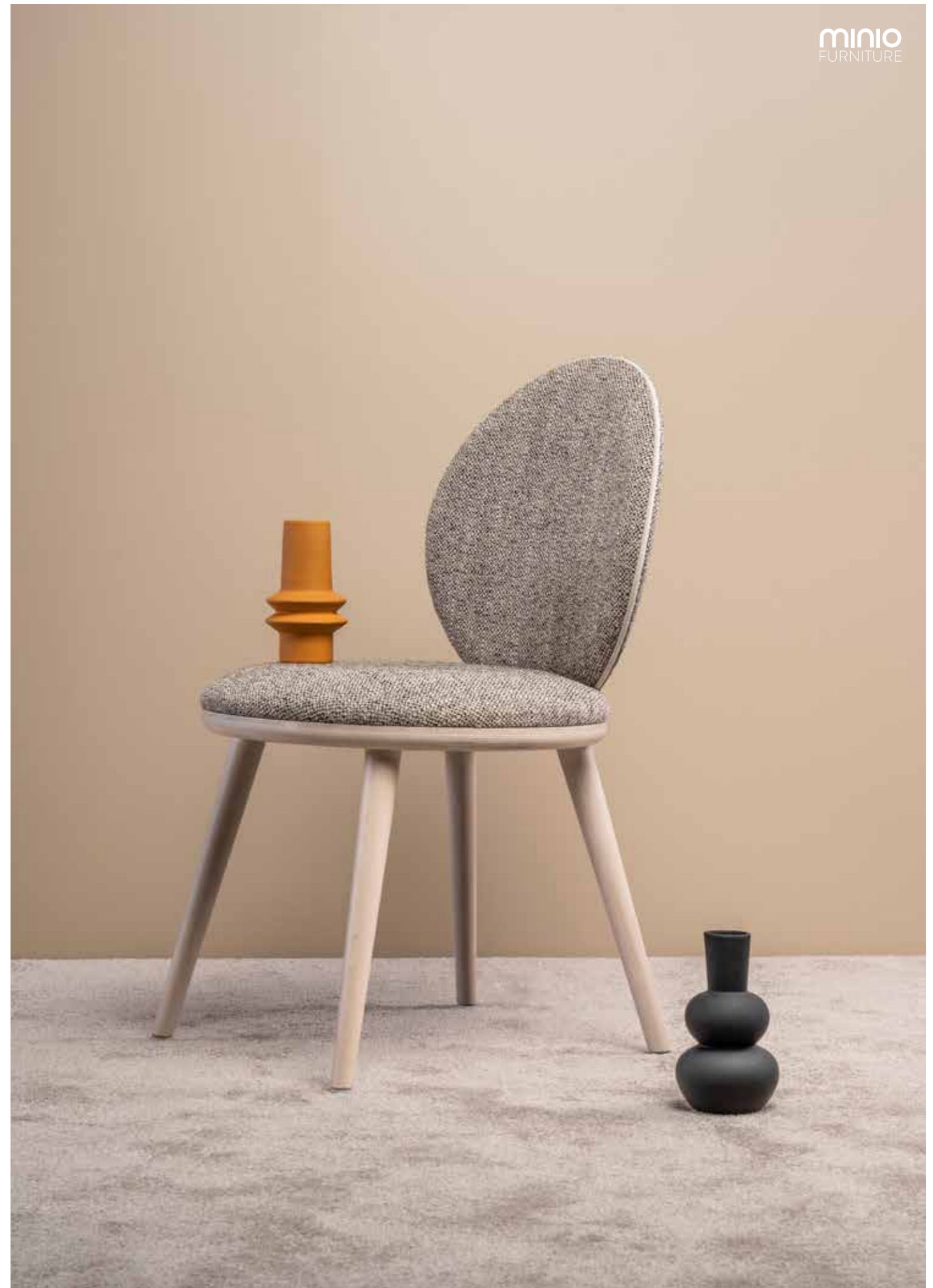

The Sada line is different due to its details and for having models with an appealing and contemporary design. Inspired by the Nordic style, with a clean image, these models provide the user with excellent comfort. In addition, they complement the space with an elegant design. The Sada was designed combining sophistication with usability.

Sada

Upholstered

Beech / Hêtre / Haya



63 cm | 24,8"

58 cm | 22,9"

79,5 cm | 31,3"

49,5 cm | 19,5"

72 cm | 28,3"

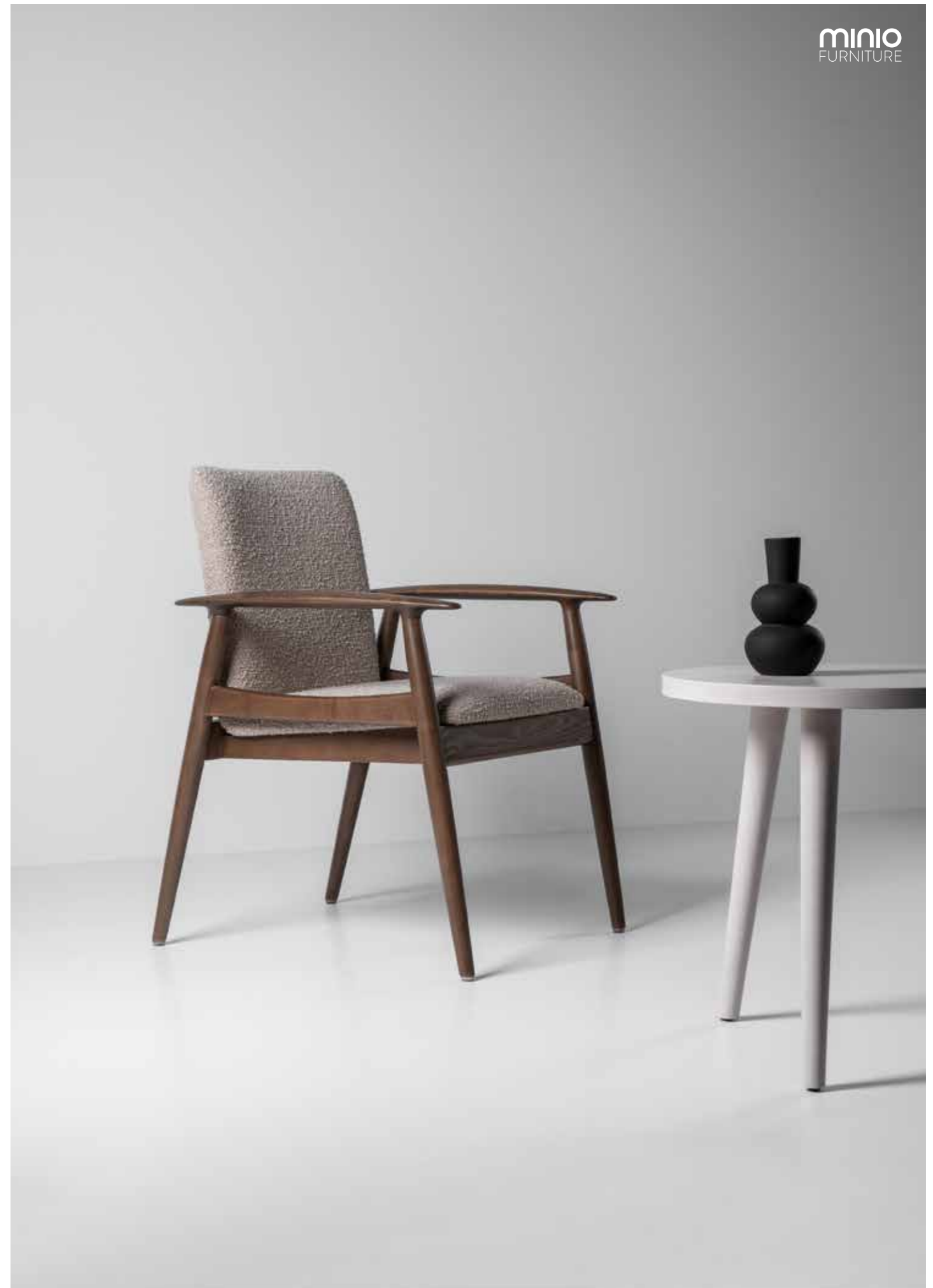

The poufs are a complement to any seating space. There are many added values, from a seat to a side table to a footrest, these simple elements play a very important role in functional sets in the decoration of a Hospitality space.

Sag Pouff

Upholstered

Beech / Hêtre / Haya

Sag Pouff Foot



∅ 45,5 cm | 17,9"

h 49,5 cm | 19,5"

Sag Pouff



∅ 45,5 cm | 17,9"

h 45,5 cm | 17,9"



A simple yet distinctive four legged chair. The leg positioning, its circular seat and the gently curved backrest characterises its architectural and graphic look and feel. Because of its aesthetic reduction in combination with the geometrical round shapes, it becomes almost iconic and sculptural. The Tis chair is available in solid wood with optional upholstered seat and/or backrest.



Tis Chair

Tis

Upholstered

Ash / Frêne / Fresno

Tis Chair

	59 cm 23,2"
	54 cm 21,3"
	75 cm 29,5"
	50 cm 19,7"
	75 cm 29,5"

Tis Chair Res

	59 cm 23,2"
	61 cm 24"
	77 cm 33,3"
	50 cm 19,7"
	75 cm 29,5"



Tis Chair

Tis Chair Res

Tis Chair

The Umay Collection consists of three banquettes with a straight seat and a carved back. Thus, in addition to the inclination of the back which increases comfort, this can be manufactured with backstitching, straight topstitching or with a pattern. It is Minio's best-selling banquette.

Umay Bench

Upholstered

Beech / Hêtre / Haya

Back black fabric / Arrière-dos en jaconas noir / contra respaldo tela negra

Umay Bench Basic



□	120 cm 47,2"
┌	72,5 cm 28,5"
└	105 cm 41,3"
└	48 cm 18,9"

Umay Bench Capitone



□	120 cm 47,2"
┌	72,5 cm 28,5"
└	105 cm 41,3"
└	48 cm 18,9"

Umay Bench Fluted



□	120 cm 47,2"
┌	72,5 cm 28,5"
└	105 cm 41,3"
└	48 cm 18,9"

Umay Bench Plinth Basic



□	120 cm 47,2"
┌	72,5 cm 28,5"
└	105 cm 41,3"
└	48 cm 18,9"

Umay Bench Plinth Capitone



□	120 cm 47,2"
┌	72,5 cm 28,5"
└	105 cm 41,3"
└	48 cm 18,9"

Umay Bench Plinth Fluted



□	120 cm 47,2"
┌	72,5 cm 28,5"
└	105 cm 41,3"
└	48 cm 18,9"





Umay Bench Fluted



Umay Bench Plinth Fluted



Umay Bench Basic
Plain backrest / Dossier Lisse / Respaldo Liso



Umay Bench Plinth Basic
Plain backrest / Dossier Lisse / Respaldo Liso



Umay Bench Capitone
Capitone Backrest / Dossier capitonné / Respaldo Capitoné



Umay Bench Plinth Capitone
Capitone backrest / Dossier capitonné / Respaldo Capitoné

The Vas Arm Collection is the perfect physical representation of functional design. It is a collection that prioritizes comfort and ergonomics and where the exquisite geometric angles make it touch perfection. Vas Arm is subtle, elegant and classy. It will be the center of attention in the project in which it is inserted, regardless of whether it is a hotel, restaurant or office project.



Vas Arm

Upholstered

Beech / Hêtre / Haya



53,5 cm | 21,1"

56 cm | 22"

76,5 cm | 30,1"

48 cm | 18,9"

67,5 cm | 26,6"







The Zen chair consists of a dining chair, that fits into any interior design project, whether in restaurants, hotels or in a residential environment. The name Zen comes from a Buddhist term, which refers to the practice of calmness and also state - "just sitting". What characterizes this chair is the design of the lateral lines, where a triangle is located, supporting the structure of the chair.



Zen

Upholstered

Ash / Frêne / Fresno

-  59 cm | 23,2"
-  61 cm | 24"
-  77 cm | 30,3"
-  49 cm | 19,3"
-  75 cm | 29,5"



MINIO
TABLES



Solid Oak Plain

Indoor



Solid Oak - ST -R10 / B20 - Matt

Solid Oak Plain

- Encimera en roble macizo seleccionado.
- Plateau en chêne massif sélectionné.
- Selected solid oak table top.

Medidas estándar / Mesures standards / Standard measures

60x60 - 70x70 - 80x80 - 90x90 cm.
110x70 - 120x80 - 140x90 cm.
60Ø - 70Ø - 80Ø - 90Ø - 100Ø - 110Ø - 120Ø cm.

23,6x23,6 - 27,6x27,6 - 31,5x31,5 - 35,4x35,4 In.
43,3x27,6 - 47,2x31,5 - 55,1x35,4 In.
23,6Ø - 27,5Ø - 31,5Ø - 35,4Ø - 39,4Ø - 43,3Ø - 47,2Ø In.

Fabricación a medida / Fabrication sur mesure / Taylor made measures

250 cm / 98,4"

Largo máximo por pieza
Longueur maximum par pièce
Maximum length in one piece



120 cm / 47,2"

X Ancho máximo por pieza
Largeur maximale d'une pièce
Maximum width in one piece



Solid Oak - ST -R10 / B20 - Matt

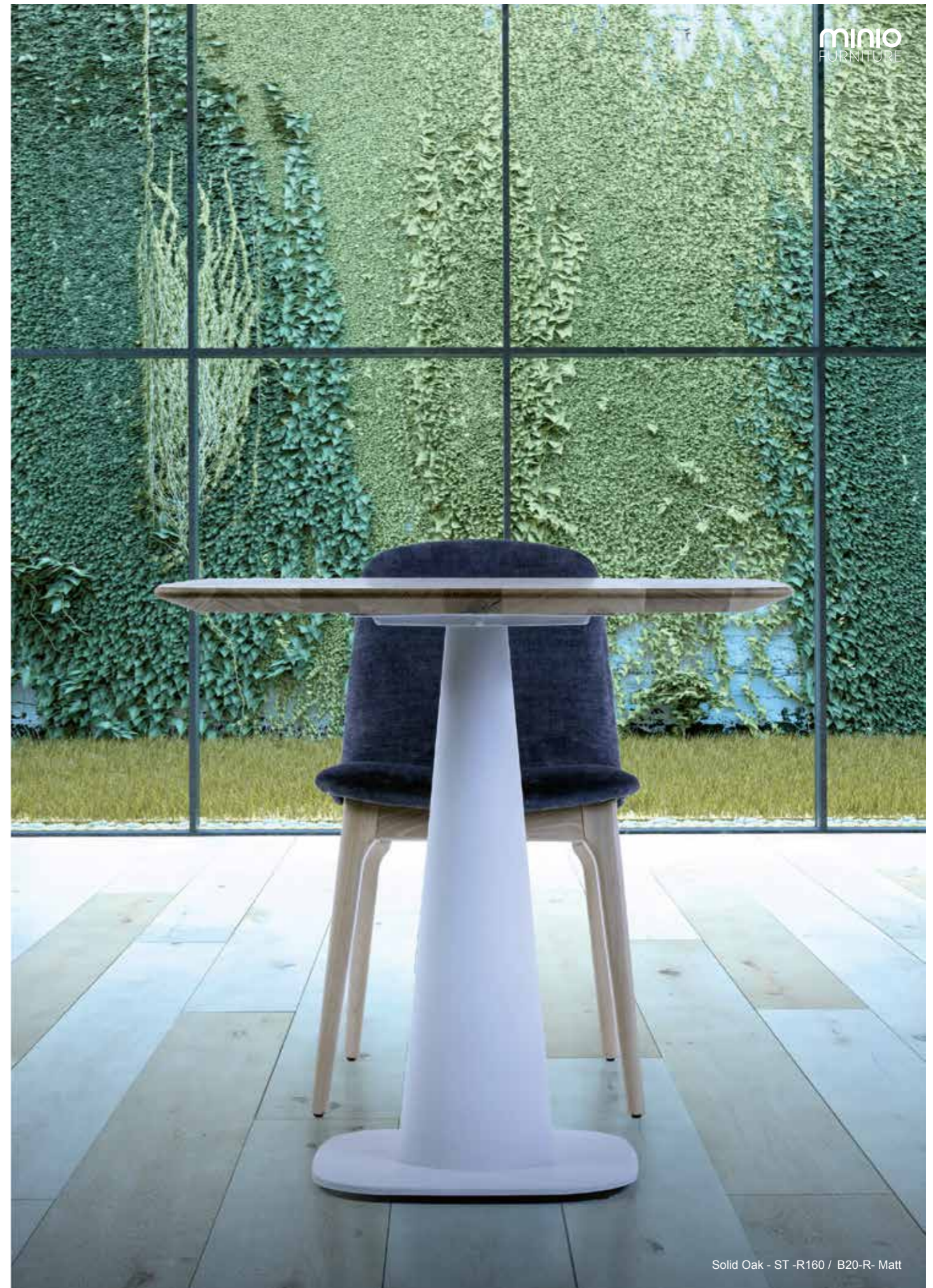

minio
FURNITURE

Solid Oak - ST -R160 / B20-R- Matt



Raw

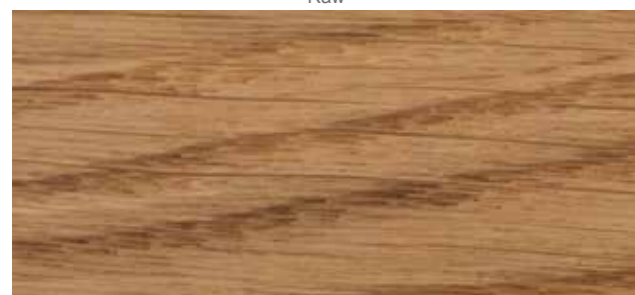

Matt



Clar

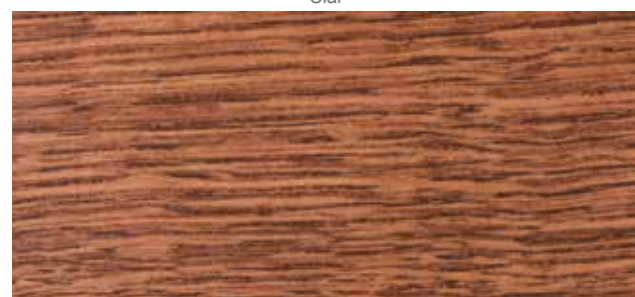

Tintor

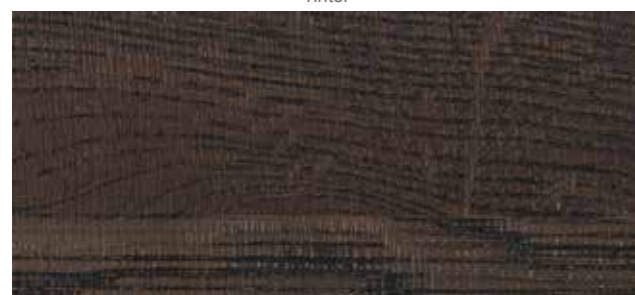

Esla

Solid Oak - ST -R10 / B20 - Raw

- Las muestras de color que se ven en las imágenes son de carácter orientativo. Las imágenes pueden diferir del tono real del producto final.

- Une image vue sur un écran (ordinateur, tablette, smartphone, etc.) ou sur un document imprimé peut faire varier la couleur/le ton des matériaux.

Forma - Forme - Shape

ST

- Encimera con 4 lados rectos.
- Plateau à 4 côtés droits.
- Table top with 4 straight sides.



ST-R10

- Encimera con 4 lados rectos y esquinas con radio de 10 mm (0,4").
- Plateau à 4 côtés droits et rayon des angles de 10mm (0,4").
- Table top with 4 straight sides and 10 mm (0,4") radius corners.

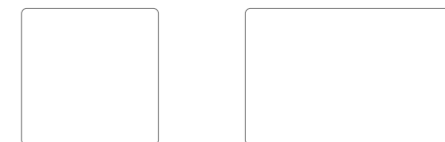

ST-R60

- Encimera con 4 lados rectos y esquinas con radio de 60 mm (2,4").
- Table à 4 côtés droits et les angles ont un rayon de 60 mm (2,4").
- Table top with 4 straight sides and 60 mm (2,4") radius corners.



2C

- Encimera con 2 lados curvos.
- Table à 2 côtés courbés et 2 côtés droits.
- Table top with 2 curved sides and 2 straight sides.

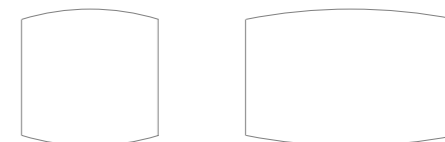

2C-R60

- Encimera con 2 lados curvos y esquinas con radio de 60 mm (2,4").
- Table à 2 côtés courbés, 2 côtés droits et les angles à un rayon de 60 mm (2,4").
- Table top with two curved sides, 2 straight sides and 60 mm (2,4") radius corners.

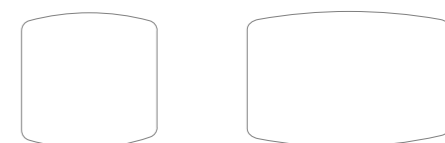

4C

- Encimera con 4 lados curvos.
- Table à 4 côtés courbés.
- Table top with 4 curved sides.

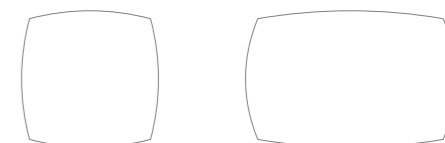

4C-R60

- Encimera con 4 lados curvos y esquinas con radio de 60 mm (2,4").
- Table à 4 côtés courbés et les angles à un rayon de 60 mm (2,4").
- Table top with 4 curved sides and 60 mm (2,4") radius corners.

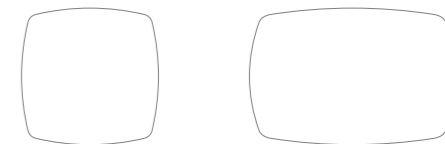

RND

- Encimera redonda.
- Plateau rond.
- Round table top.

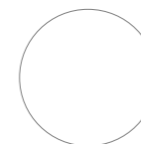

OCT

- Encimera con 8 lados.
- Plateau à 8 côtés.
- Table top with 8 sides.

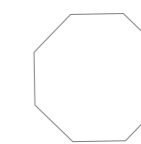

Canto - Chant - Edge



RT

- Canto recto standard.
- Chant droit standard.
- Standard straight edges.



B20

- Canto con bisel a 20° y plano de 10 mm (0,4").
- Chant avec biseau de 20° et droit de 10 mm (0,4").
- 20° chamfer edges and 10 mm (0,4") face.



B45

- Canto con bisel a 45° y plano de 10 mm (0,4").
- Chant avec biseau de 45° et droit de 10 mm (0,4").
- 45° chamfer edges and 10 mm (0,4") face.



B20-M

- Canto con bisel a 20° y ¼ de caña de 10 mm (0,4").
- Chant avec biseau de 20° et arrondi ¼ de cercle.
- 20° chamfer edges and rounded ¼ bullnose.



RD

- Canto ½ caña.
- Chant arrondi.
- Bullnose edges.



B20-R

- Canto con bisel a 20° y 1/2 caña.
- Chant avec biseau de 20° et arrondi ½ de rond.
- 20° chamfer and rounded to full bullnose.

Solid Oak Brush

Indoor



Solid Oak Brush - ST - R60 / B20-M - Raw

Solid Oak Brush

- Encimera de roble macizo cepillado a contraveta en su cara superior.
- Plateau en chêne massif. Face supérieure brossée.
- Solid oak brushed against the grain table top on its surface.

Medidas estándar / Mesures standards / Standard measures

60x60 - 70x70 - 80x80 - 90x90
110x70 - 120x80 - 140x90
60Ø - 70Ø - 80Ø - 90Ø - 100Ø - 110Ø - 120Ø

23,6x23,6 - 27,6x27,6 - 31,5x31,5 - 35,4x35,4 In.
43,3x27,6 - 47,2x31,5 - 55,1x35,4 In.
23,6Ø - 27,5Ø - 31,5Ø - 35,4Ø - 39,4Ø - 43,3Ø - 47,2Ø In.

Fabricación a medida / Fabrication sur mesure / Taylor made measures

250 cm / 98,4"

Largo máximo por pieza
Longueur maximum par pièce
Maximum length in one piece

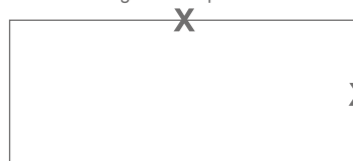

120 cm / 47,2"
X Ancho máximo por pieza
Longueur maximum par pièce
Maximum width in one piece



Solid Oak Brush - ST -R60 / B20-M - Matt



Solid Oak Brush - ST -R60 / B20-M - Raw



Raw



Matt



Esla

Solid Brush - ST -R60 / B20-M - Matt

- Las muestras de color que se ven en las imagenes son de carácter orientativo. Las imágenes pueden diferir del tono real del producto final.
 - Les échantillons de couleur imprimés sont fournis à titre indicatif uniquement. Ils peuvent différer du ton du produit final.
 - Printed color samples are for guidance only. They may differ from the actual tone of the final product.

Forma - Forme - Shape

ST

- Encimera con 4 lados rectos.
- Plateau à 4 côtés droits.
- Table top with 4 straight sides.



ST-R10

- Encimera con 4 lados rectos y esquinas con radio de 10 mm (0,4").
- Plateau à 4 côtés droits et rayon des angles de 10mm (0,4").
- Table top with 4 straight sides and 10 mm (0,4") radius corners.



ST-R60

- Encimera con 4 lados rectos y esquinas con radio de 60 mm (2,4").
- Table à 4 côtés droits et les angles ont un rayon de 60 mm (2,4").
- Table top with 4 straight sides and 60 mm (2,4") radius corners.



2C

- Encimera con 2 lados curvos.
- Table à 2 côtés courbés et 2 côtés droits.
- Table top with 2 curved sides and 2 straight sides.

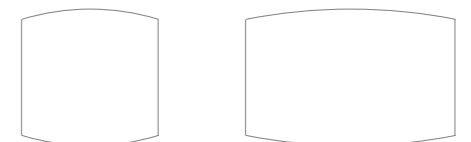

2C-R60

- Encimera con 2 lados curvos y esquinas con radio de 60 mm (2,4").
- Table à 2côtés courbés, 2 côtés droits et les angles à un rayon de 60 mm (2,4").
- Table top with two curved sides, 2 straight sides and 60 mm (2,4") radius corners.

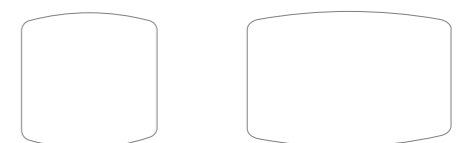

4C

- Encimera con 4 lados curvos.
- Table à 4 côtés courbés.
- Table top with 4 curved sides.

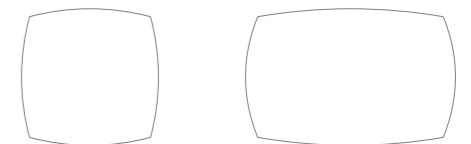

4C-R60

- Encimera con 4 lados curvos y esquinas con radio de 60 mm (2,4").
- Table à 4 côtés courbés et les angles à un rayon de 60 mm (2,4").
- Table top with 4 curved sides and 60 mm (2,4") radius corners.

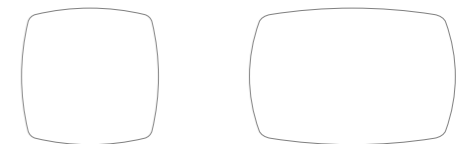

RND

- Encimera redonda.
- Plateau rond.
- Round table top.

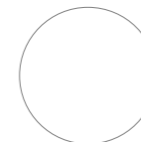

OCT

- Encimera con 8 lados.
- Plateau à 8 côtés.
- Table top with 8 sides.

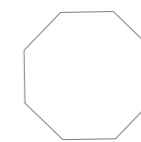

Canto - Chant - Edge

RT

- Canto recto standard.
- Chant droit standard.
- Standard straight edges.

B45

- Canto con bisel a 45° y plano de 10 mm (0,4").
- Chant avec biseau de 45° et droit de 10 mm (0,4").
- 45° chamfer edges and 10 mm (0,4") face.

B20

- Canto con bisel a 20° y plano de 10 mm (0,4").
- Chant avec biseau de 20° et droit de 10 mm (0,4").
- 20° chamfer edges and 10 mm (0,4") face.

B20-M

- Canto con bisel a 20° y ¼ de caña de 10 mm (0,4").
- Chant avec biseau de 20° et arrondi ¼ de cercle.
- 20° chamfer edges and rounded ¼ bullnose.

Solid Oak Used

Indoor



Solid Oak Used - ST / RT - Tintor

Solid Oak Used

- Encimera en roble macizo desgastado y patinado de aspecto envejecido.
- Plateau en chêne massif. Patiné avec aspect vieilli.
- Worn and patinated solid oak table top.

Medidas estándar / Mesures standards / Standard measures

60x60 - 70x70 - 80x80 - 90x90
110x70 - 120x80 - 140x90
60Ø - 70Ø - 80Ø - 90Ø - 100Ø - 110Ø - 120Ø

23,6x23,6 - 27,6x27,6 - 31,5x31,5 - 35,4x35,4 In.
43,3x27,6 - 47,2x31,5 - 55,1x35,4 In.
23,6Ø - 27,5Ø - 31,5Ø - 35,4Ø - 39,4Ø - 43,3Ø - 47,2Ø In.

Fabricación a medida / Fabrication sur mesure / Taylor made measures

250 cm / 98,4"

Largo máximo por pieza
Longueur maximum par pièce
Maximum length in one piece

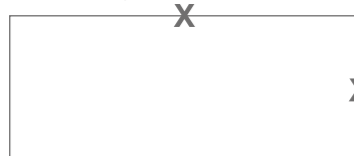

120 cm / 47,2"

Ancho máximo por pieza
Longueur maximum par pièce
Maximum width in one piece

Solid Used - ST / RT - Tintor
Solid Used - ST / RT - Clar



Solid Oak Used - ST / RT - Tintor



Natur

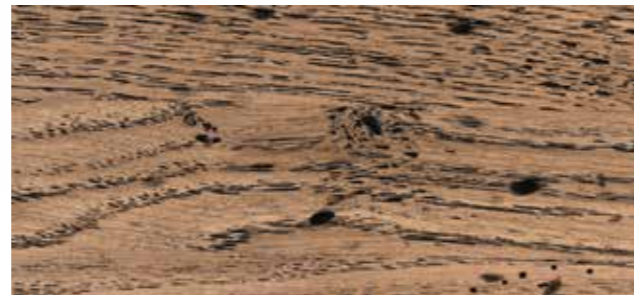

Clar



Champ



Tintor

- Las muestras de color que se ven en las imágenes son de carácter orientativo. Las imágenes pueden diferir del tono real del producto final.
 - Une image vue sur un écran (ordinateur, tablette, smartphone, etc.) ou sur un document imprimé peut faire varier la couleur/le ton des matériaux.
 - Printed color samples are for guidance only. They may differ from the actual tone of the final product.

Solid Oak Used - ST / RT - Clar

Forma - Forme - Shape

ST

- Encimera con 4 lados rectos.
- Plateau à 4 côtés droits
- Table top with 4 straight sides.

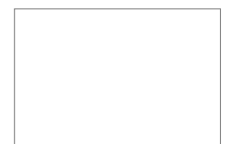

RND

- Encimera redonda.
- Plateau rond.
- Round table top.

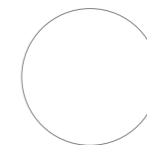

Canto - Chant - Edge

3 cm. / 1,2" **RT**



- Canto recto standard.
- Chant droit standard.
- Standard straight edges.

Solid Pine Used

Indoor



Solid Pine Used - ST / RT - Champ

Solid Pine Used

- Encimera de pino macizo desgastado y patinado de aspecto usado.
- Plateau en pin massif. Patiné avec aspect usé.
- Worn and patinated solid pin table top.

Medidas estándar / Mesures standards / Standard measures

60x60 - 70x70 - 80x80 - 90x90
110x70 - 120x80 - 140x90
60Ø - 70Ø - 80Ø - 90Ø - 100Ø - 110Ø - 120Ø

23,6x23,6 - 27,6x27,6 - 31,5x31,5 - 35,4x35,4 In.
43,3x27,6 - 47,2x31,5 - 55,1x35,4 In.
23,6Ø - 27,5Ø - 31,5Ø - 35,4Ø - 39,4Ø - 43,3Ø - 47,2Ø In.

Fabricación a medida / Fabrication sur mesure / Taylor made measures

250 cm / 98,4"

Largo máximo por pieza
Longueur maximum par pièce
Maximum length in one piece



180 cm / 70,9"
Ancho máximo por pieza
Longueur maximum par pièce
Maximum width in one piece



Solid Pine Used - ST / RT - Champ

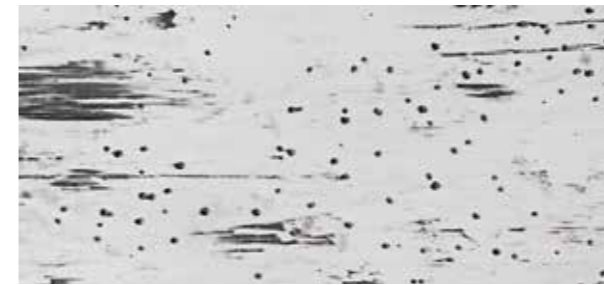

Blanc



Natur



Claro

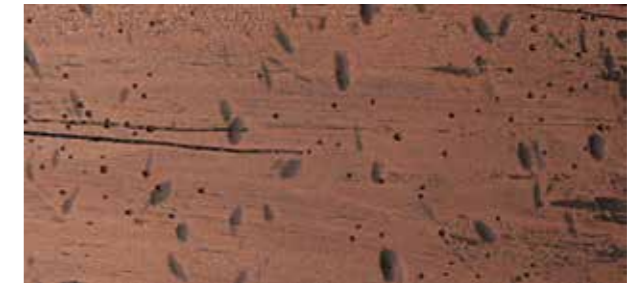

Champ



Tintor



Ama



Roj

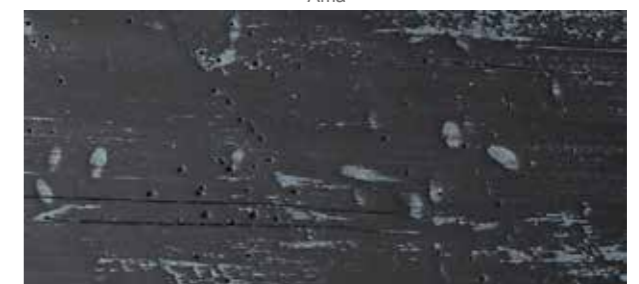

Neg

Forma - Forme - Shape

ST

- Encimera con 4 lados rectos.
- Plateau à 4 côtés droits.
- Table top with 4 straight sides.



RND

- Encimera redonda.
- Plateau rond.
- Round table top.

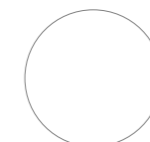

Canto - Chant - Edge

3 cm. / 1,2" **RT**

- Canto recto standard.
- Chant droit standard.
- Standard straight edges.

- Las muestras de color que se ven en las imágenes son de carácter orientativo. Las imágenes pueden diferir del tono real del producto final.
- Une image vue sur un écran (ordinateur, tablette, smartphone, etc.) ou sur un document imprimé peut faire varier la couleur/le ton des matériaux.
- Printed color samples are for guidance only. They may differ from the actual tone of the final product.

Cover Ceramic

Indoor

Outdoor available



Cover Ceramic - RND / B45 - Blanco 9003

Cover Ceramic

- Encimera MDF lacado con efecto cerámico. Disponible acabado para exterior.
- Plateau en MDF laqué effet céramic. Finition extérieure disponible.
- Lacquered MDF table top with a ceramic design. Outdood finish available

Medidas estándar / Mesures standards / Standard measures

60x60 - 70x70 - 80x80 - 90x90
110x70 - 120x80 - 140x90
60Ø - 70Ø - 80Ø - 90Ø - 100Ø - 110Ø - 120Ø

23,6x23,6 - 27,6x27,6 - 31,5x31,5 - 35,4x35,4 In.
43,3x27,6 - 47,2x31,5 - 55,1x35,4 In.
23,6Ø - 27,5Ø - 31,5Ø - 35,4Ø - 39,4Ø - 43,3Ø - 47,2Ø In.

Fabricación a medida / Fabrication sur mesure / Taylor made measures

250 cm / 98,4"

Largo máximo por pieza
Longueur maximum par pièce
Maximum length in one piece

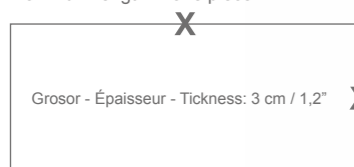

180 cm / 70,9"

Ancho máximo por pieza
Longueur maximum par pièce
Maximum width in one piece



Cover Ceramic - OCT / B20 -Piedra 7044



Cover Ceramic - 2C / B20 -Gris 7012

Cover Ceramic



Blanco 9003-1



Crema 1013



Piedra 7044



Barro 7030



Gris 7045



Grafito 7012

- Las muestras de color que se ven en las imágenes son de carácter orientativo. Las imágenes pueden diferir del tono real del producto final.

- Une image vue sur un écran (ordinateur, tablette, smartphone, etc.) ou sur un document imprimé peut faire varier la couleur/le ton des matériaux.

- Printed color samples are for guidance only. They may differ from the actual tone of the final product.

Cover Ceramic

Forma - Forme - Shape

ST

- Encimera con 4 lados rectos.
- Plateau à 4 côtés droits.
- Table top with 4 straight sides.



ST-R10

- Encimera con 4 lados rectos y esquinas con radio de 10 mm (0,4").
- Plateau à 4 côtés droits et rayon des angles de 10mm (0,4").
- Table top with 4 straight sides and 10 mm (0,4") radius corners.



ST-R60

- Encimera con 4 lados rectos y esquinas con radio de 60 mm (2,4").
- Table à 4 côtés droits et les angles ont un rayon de 60 mm (2,4").
- Table top with 4 straight sides and 60 mm (2,4") radius corners.



2C

- Encimera con 2 lados curvos.
- Table à 2 côtés courbés et 2 côtés droits.
- Table top with 2 curved sides and 2 straight sides.

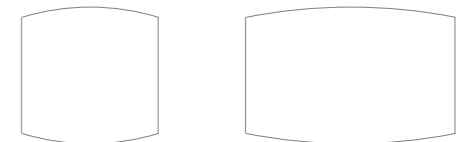

2C-R60

- Encimera con 2 lados curvos y esquinas con radio de 60 mm (2,4").
- Table à 2 côtés courbés, 2 côtés droits et les angles à un rayon de 60 mm (2,4").
- Table top with two curved sides, 2 straight sides and 60 mm (2,4") radius corners.

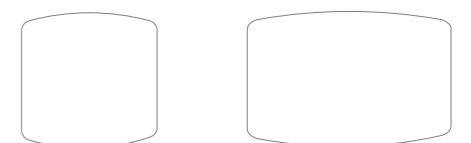

4C

- Encimera con 4 lados curvos.
- Table à 4 côtés courbés.
- Table top with 4 curved sides.

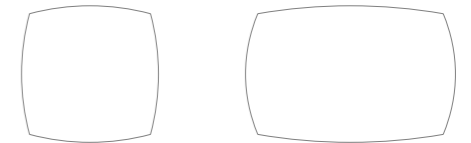

4C-R60

- Encimera con 4 lados curvos y esquinas con radio de 60 mm (2,4").
- Table à 4 côtés courbés et les angles à un rayon de 60 mm (2,4").
- Table top with 4 curved sides and 60 mm (2,4") radius corners.

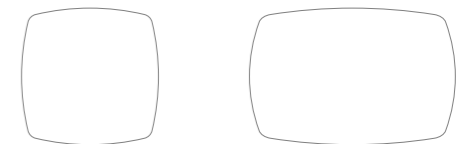

RND

- Encimera redonda.
- Plateau rond.
- Round table top.

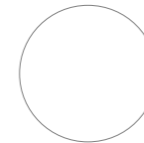

OCT

- Encimera con 8 lados.
- Plateau à 8 côtés.
- Table top with 8 sides.

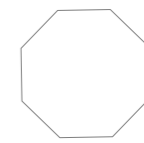

Canto - Chant - Edge

RT

- Canto recto standard.
- Chant droit standard.
- Standard straight edges.

3 cm. / 1,2"



B20

- Canto con bisel a 20° y plano de 10 mm (0,4").
- Chant avec biseau de 20° et droit de 10 mm (0,4").
- 20° chamfer edges and 10 mm (0,4") face.

3 cm. / 1,2"



B45

- Canto con bisel a 45° y plano de 10 mm (0,4").
- Chant avec biseau de 45° et droit de 10 mm (0,4").
- 45° chamfer edges and 10 mm (0,4") face.

3 cm. / 1,2"

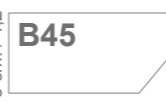

B20-M

- Canto con bisel a 20° y ¼ de caña de 10 mm (0,4").
- Chant avec biseau de 20° et arrondi ¼ de cercle.
- 20° chamfer edges and rounded ¼ bullnose.

3 cm. / 1,2"



RD

- Canto ½ caña.
- Chant arrondi.
- Bullnose edges.

3 cm. / 1,2"



B20-R

- Canto con bisel a 20° y 1/2 caña.
- Chant avec biseau de 20° et arrondi ½ de rond.
- 20° chamfer and rounded to full bullnose.

3 cm. / 1,2"



Cover Marble

Indoor

Outdoor available



Cover Marble - ST-R60 / RD - Gold 9003

Cover Marble - RND / RD - Musgo 9003

Cover Marble

- Encimera de MDF con acabado 3D efecto mármol. Disponible acabado para exterior.
- Plateau en DM finition 3D effet marbre. Finition extérieure disponible.
- MDF table top with a 3D marble design. Outdoor finish available

Medidas estándar / Mesures standards / Standard measures

60x60 - 70x70 - 80x80 - 90x90
110x70 - 120x80 - 140x90
60Ø - 70Ø - 80Ø - 90Ø - 100Ø - 110Ø - 120Ø

23,6x23,6 - 27,6x27,6 - 31,5x31,5 - 35,4x35,4 In.
43,3x27,6 - 47,2x31,5 - 55,1x35,4 In.
23,6Ø - 27,5Ø - 31,5Ø - 35,4Ø - 39,4Ø - 43,3Ø - 47,2Ø In.

Fabricación a medida / Fabrication sur mesure / Taylor made measures

180 cm / 70,9"

Largo máximo por pieza
Longueur maximum par pièce
Maximum length in one piece

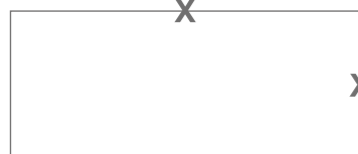

120 cm / 47,2"

X Ancho máximo por pieza
Longueur maximum par pièce
Maximum width in one piece



Cover Marble - ST-R60 / RD - Blanco 9003



Cover Marble - ST / RD - Mármol Negro

Cover Marble



Calacatta 9003



Gold 9003



Blanco 9003



Crema 9003

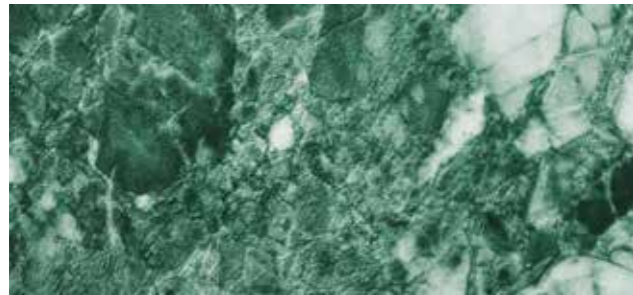

Musgo 9003

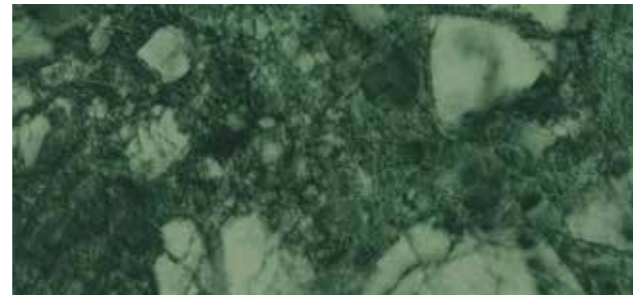

Musgo 6023

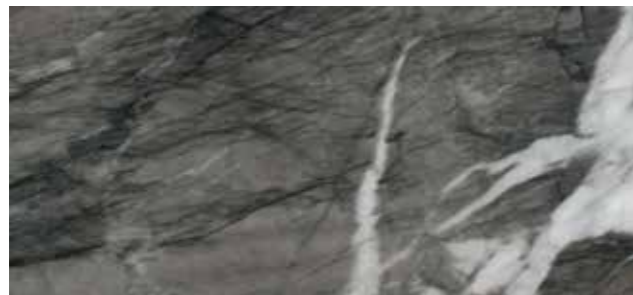

Mármol gris



Mármol negro

- Las muestras de color que se ven en las imágenes son de carácter orientativo. Las imágenes pueden diferir del tono real del producto final.
- Une image vue sur un écran (ordinateur, tablette, smartphone, etc.) ou sur un document imprimé peut faire varier la couleur/le ton des matériaux).
- Printed color samples are for guidance only. They may differ from the actual tone of the final product.

Cover Marble



Travertino Romano 9003



- Les échantillons de couleur imprimés sont fournis à titre indicatif uniquement. Ils peuvent différer du ton du produit final.
- Printed color samples are for guidance only. They may differ from the actual tone of the final product.

Cover Marble - ST / B45 - Travertino Romano 9003

Cover Marble



Cover Marble - RND / RD - Calacatta 9003



Cover Marble - RND / RD - Statuario 9003

Cover Marble

Forma - Forme - Shape

ST

- Encimera con 4 lados rectos.
- Plateau à 4 côtés droits.
- Table top with 4 straight sides.



ST-R10

- Encimera con 4 lados rectos y esquinas con radio de 10 mm (0,4").
- Plateau à 4 côtés droits et rayon des angles de 10mm (0,4").
- Table top with 4 straight sides and 10 mm (0,4") radius corners.



ST-R60

- Encimera con 4 lados rectos y esquinas con radio de 60 mm (2,4").
- Table à 4 côtés droits et les angles ont un rayon de 60 mm (2,4").
- Table top with 4 straight sides and 60 mm (2,4") radius corners.



2C

- Encimera con 2 lados curvos.
- Table à 2 côtés courbés et 2 côtés droits.
- Table top with 2 curved sides and 2 straight sides.

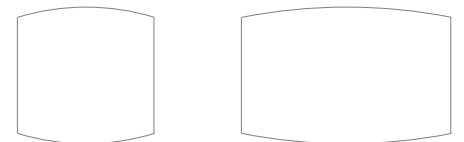

2C-R60

- Encimera con 2 lados curvos y esquinas con radio de 60 mm (2,4").
- Table à 2 côtés courbés, 2 côtés droits et les angles à un rayon de 60 mm (2,4").
- Table top with two curved sides, 2 straight sides and 60 mm (2,4") radius corners.

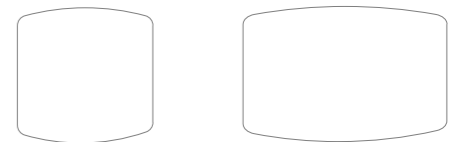

4C

- Encimera con 4 lados curvos.
- Table à 4 côtés courbés.
- Table top with 4 curved sides.

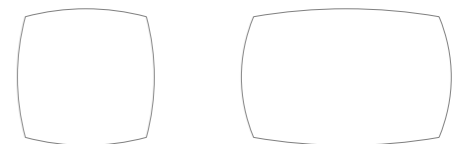

4C-R60

- Encimera con 4 lados curvos y esquinas con radio de 60 mm (2,4").
- Table à 4 côtés courbés et les angles à un rayon de 60 mm (2,4").
- Table top with 4 curved sides and 60 mm (2,4") radius corners.

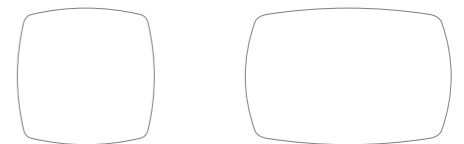

RND

- Encimera redonda.
- Plateau rond.
- Round table top.

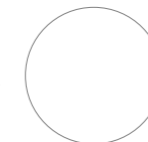

OCT

- Encimera con 8 lados
- Plateau à 8 côtés.
- Table top with 8 sides.

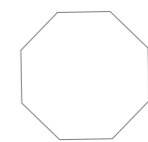

Canto - Chant - Edge

RT

- Canto recto standard.
- Chant droit standard.
- Standard straight edges.

3 cm. / 1,2"



B45

- Canto con bisel a 45° y plano de 10 mm (0,4").
- Chant avec biseau de 45° et droit de 10 mm (0,4").
- 45° chamfer edges and 10 mm (0,4") face.

3 cm. / 1,2"

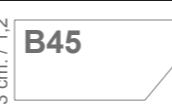

RD

- Canto ½ caña.
- Chant arrondi.
- Bullnose edges.

3 cm. / 1,2"



H-Tres CH Beech/RB Oak

Indoor

H-Tres CH Beech / RB Oak

- Encimera de MDF rechapado y canteado con madera natural de haya o roble.
- Plateau MDF placage et chant en hêtre ou en chêne naturel.
- Table top of MDF veneered and edged with natural beech or oak wood.

Medidas estándar / Mesures standards / Standard measures

60x60 - 70x70 - 80x80 - 90x90
110x70 - 120x80 - 140x90
60Ø - 70Ø - 80Ø - 90Ø - 100Ø - 110Ø - 120Ø

23,6x23,6 - 27,6x27,6 - 31,5x31,5 - 35,4x35,4 In.
43,3x27,6 - 47,2x31,5 - 55,1x35,4 In.
23,6Ø - 27,5Ø - 31,5Ø - 35,4Ø - 39,4Ø - 43,3Ø - 47,2Ø In.

Fabricación a medida / Fabrication sur mesure / Taylor made measures

250 cm / 98,4"

Largo máximo por pieza
Longueur maximum par pièce
Maximum length in one piece

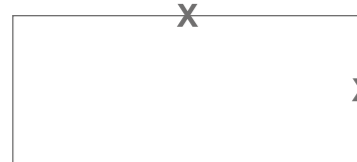

120 cm / 47,2"

Ancho máximo por pieza
Longueur maximum par pièce
Maximum width in one piece



H-Tres- RND / RT - Haya T170



Tinte 160



Tinte 163



Tinte 165



Tinte 501

Colores Ral disponibles / Couleurs Ral disponibles / Ral colors available

Forma - Forme - Shape

ST

- Encimera con 4 lados rectos.
- Plateau à 4 côtés droits
- Table top with 4 straight sides.



RND

- Encimera redonda.
- Plateau rond.
- Round table top.

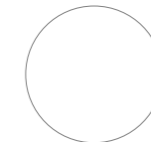

Canto - Chant - Edge

3 cm. / 1,2" **RT**

- Canto recto standard.
- Chant droit standard.
- Standard straight edges.



H-Tres- ST / RT - Haya T162

- Las muestras de color que se ven en las imágenes son de carácter orientativo. Las imágenes pueden diferir del tono real del producto final.
- Une image vue sur un écran (ordinateur, tablette, smartphone, etc.) ou sur un document imprimé peut faire varier la couleur/le ton des matériaux.
- Printed color samples are for guidance only. They may differ from the actual tone of the final product.

Multilam Liso

Indoor

Outdoor available



- Las muestras de color que se ven en las imágenes son de carácter orientati-
vo. Las imágenes pueden diferir del tono real del producto final.
- Une image vue sur un écran (ordinateur, tablette, smartphone, etc.) ou sur un
document imprimé peut faire varier la couleur/le ton des matériaux.
- Printed color samples are for guidance only. They may differ from the actual
tone of the final product.



Raw



Matt



Clar



Tintor



Esla

Multilam Liso

- Encimera de multilaminado de abedul con chapa natural de roble. Disponible acabado para exterior.
- Plateau en multiplis de bouleau avec placage naturel de chêne. Finition extérieure disponible.
- Multi-laminate birch table top with natural oak veneer. Outdoor finish available

Multilam Liso - 2C-R60 / B20-M - Matt

Medidas estándar / Mesures standards / Standard measures

60x60 - 70x70 - 80x80 - 90x90
110x70 - 120x80 - 140x90
60Ø - 70Ø - 80Ø - 90Ø - 100Ø - 110Ø - 120Ø

23,6x23,6 - 27,6x27,6 - 31,5x31,5 - 35,4x35,4 In.
43,3x27,6 - 47,2x31,5 - 55,1x35,4 In.
23,6Ø - 27,5Ø - 31,5Ø - 35,4Ø - 39,4Ø - 43,3Ø - 47,2Ø In.

Fabricación a medida / Fabrication sur mesure / Taylor made measures

250 cm / 98,4"

Largo máximo por pieza
Longueur maximum par pièce
Maximum length in one piece

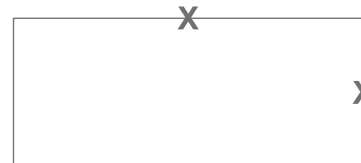

120 cm / 47,2"

X Ancho máximo por pieza
Longueur maximum par pièce
Maximum width in one piece



Multilam Liso - 2C-R60 / B20-M - Clar



Multilam Liso - 2C-R60 / B20-M - Matt

Multilam Rustik

Indoor

Outdoor available



Multilam Rustik - ST / B20 - Matt

Multilam Rustik

- Encimera de multilaminado de abedul con chapa natural de roble rústico. Disponible acabado para exterior.
- Plateau en multiplis de bouleau avec placage naturel en chêne rustique.
- Multi-laminate birch table top with natural old oak. Outdoor finish available.

Medidas estándar / Mesures standards / Standard measures

60x60 - 70x70 - 80x80 - 90x90
110x70 - 120x80 - 140x90
60Ø - 70Ø - 80Ø - 90Ø - 100Ø - 110Ø - 120Ø

23,6x23,6 - 27,6x27,6 - 31,5x31,5 - 35,4x35,4 In.
43,3x27,6 - 47,2x31,5 - 55,1x35,4 In.
23,6Ø - 27,5Ø - 31,5Ø - 35,4Ø - 39,4Ø - 43,3Ø - 47,2Ø In.

Fabricación a medida / Fabrication sur mesure / Taylor made measures

250 cm / 98,4"

Largo máximo por pieza
Longueur maximum par pièce
Maximum length in one piece



120 cm / 47,2"

Ancho máximo por pieza
Longueur maximum par pièce
Maximum width in one piece



Multilam Rustik - RND / B45 - Raw



Multilam Rustik - RND / B45 - Blanqueado



Raw



Claro



Matt



Tintor



Blanqueado

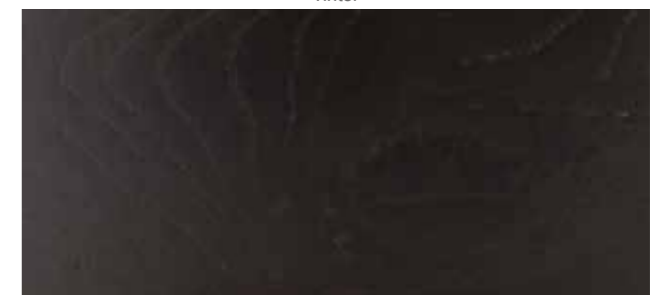

Esla

- Las muestras de color que se ven en las imágenes son de carácter orientativo. Las imágenes pueden diferir del tono real del producto final.
- Une image vue sur un écran (ordinateur, tablette, smartphone, etc.) ou sur un document imprimé peut faire varier la couleur/le ton des matériaux.
- Printed color samples are for guidance only. They may differ from the actual tone of the final product.

Multilam Olivato

Indoor

Outdoor available



Multilam Olivato - 4C / B20-M - Raw

Multilam Olivato

- Encimera de multilaminado de abedul con chapa natural de fresno olivato. Disponible acabado para exterior.

- Plateau en multiplis de bouleau avec placage en frêne olive. Finition extérieure disponible.

- Multi-laminate birch table top with natural ash olive veneer. Outdoor finish available

Medidas estándar / Mesures standards / Standard measures

60x60 - 70x70 - 80x80 - 90x90
110x70 - 120x80 - 140x90
60Ø - 70Ø - 80Ø - 90Ø - 100Ø - 110Ø - 120Ø

23,6x23,6 - 27,6x27,6 - 31,5x31,5 - 35,4x35,4 In.
43,3x27,6 - 47,2x31,5 - 55,1x35,4 In.
23,6Ø - 27,5Ø - 31,5Ø - 35,4Ø - 39,4Ø - 43,3Ø - 47,2Ø In.

Fabricación a medida / Fabrication sur mesure / Taylor made measures

250 cm / 98,4"

Largo máximo por pieza
Longueur maximum par pièce
Maximum length in one piece



120 cm / 47,2"

X Ancho máximo por pieza
Longueur maximum par pièce
Maximum width in one piece

Multilam Olivato - 4C-R60 / B20-M - Matt



Multilam Olivato - ST-R60 / B20 - Tintor



Raw



Matt



Clar



Tintor

- Las muestras de color que se ven en las imágenes son de carácter orientativo. Las imágenes pueden diferir del tono real del producto final.
- Une image vue sur un écran (ordinateur, tablette, smartphone, etc.) ou sur un document imprimé peut faire varier la couleur/le ton des matériaux.
- Printed color samples are for guidance only. They may differ from the actual tone of the final product.



Multilam Liso



Multilam Rustik



Multilam Olivato

Forma - Forme - Shape

ST

- Encimera con 4 lados rectos.
- Plateau à 4 côtés droits
- Table top with 4 straight sides.



ST-R10

- Encimera con 4 lados rectos y esquinas con radio de 10 mm (0,4").
- Plateau à 4 côtés droits et rayon des angles de 10mm (0,4").
- Table top with 4 straight sides and 10 mm (0,4") radius corners.



ST-R60

- Encimera con 4 lados rectos y esquinas con radio de 60 mm (2,4").
- Table à 4 côtés droits et les angles ont un rayon de 60 mm (2,4").
- Table top with 4 straight sides and 60 mm (2,4") radius corners.



2C

- Encimera con 2 lados curvos.
- Table à 2 côtés courbés et 2 côtés droits.
- Table top with 2 curved sides and 2 straight sides.

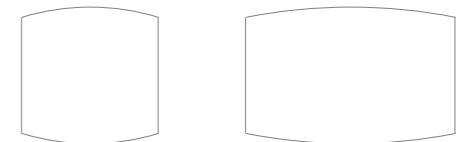

2C-R60

- Encimera con 2 lados curvos y esquinas con radio de 60 mm (2,4").
- Table à 2côtés courbés, 2 côtés droits et les angles à un rayon de 60 mm (2,4").
- Table top with two curved sides, 2 straight sides and 60 mm (2,4") radius corners.

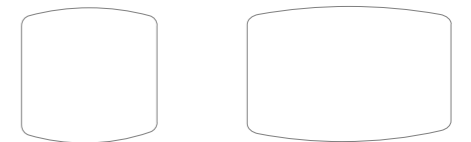

4C

- Encimera con 4 lados curvos.
- Table à 4 côtés courbés.
- Table top with 4 curved sides.

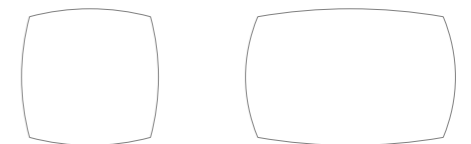

4C-R60

- Encimera con 4 lados curvos y esquinas con radio de 60 mm (2,4").
- Table à 4 côtés courbés et les angles à un rayon de 60 mm (2,4").
- Table top with 4 curved sides and 60 mm (2,4") radius corners.

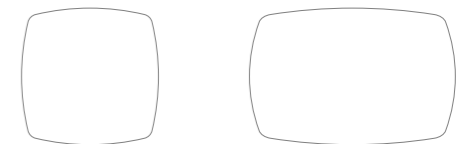

RND

- Encimera redonda.
- Plateau rond.
- Round table top.

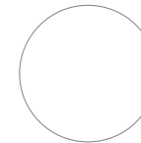

OCT

- Encimera con 8 lados
- Plateau à 8 côtés.
- Table top with 8 sides.

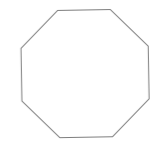

Canto - Chant - Edge



RT

- Canto recto standard.
- Chant droit standard.
- Standard straight edges.



B20

- Canto con bisel a 20° y plano de 10 mm (0,4").
- Chant avec biseau de 20° et droit de 10 mm (0,4").
- 20° chamfer edges and 10 mm (0,4") face.

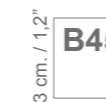

B45

- Canto con bisel a 45° y plano de 10 mm (0,4").
- Chant avec biseau de 45° et droit de 10 mm (0,4").
- 45° chamfer edges and 10 mm (0,4") face.



B20-M

- Canto con bisel a 20° y ¼ de caña de 10 mm (0,4").
- Chant avec biseau de 20° et arrondi ¼ de cercle.
- 20° chamfer edges and rounded ¼ bullnose.

Alno

Indoor Cover Ceramic Colors | Lacquered Ral Colors (ver/voir/see pg 97-99)



Alno H72 - Ral 9005TX



Alno Big H72 - Ral 9005TX



Alno High H107 x2 - Ral 9005TX

Alno

- Base para mesa de acero con tubos de 16 mm de diámetro y base maciza de 10 mm de espesor. Reguladores en base. Montaje recomendado con encimeras cuadradas, rectangulares o redondas. Se sirve montado.

- Pied pour table d'acier avec tubes de Ø16 mm et une base massive de 10 mm épaisseur, Montage compatible avec les plateaux carrés, rectangulaires et rond. Pieds réglables. Livré monté. Vérins de réglage. Livré monté.

- Steel table base with 60 mm diameter tubes and 10 mm thick solid base. Height regulators. Recommended for square, rectangular or round table tops. Delivered assembled.



Base Alno h72 - Ral 9003TX - Encimera Cover Marble Calacatta 9003



Alno High H107 x2 - Ral 9003TX - Encimera Solid Brush Matt

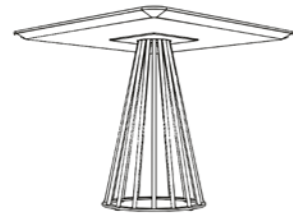

Alno Big H72 - Ral 9005TX - Encimera Finger Oak Clar

**Alno H72**

Altura de la base / Hauteur du pied / Height of the base: 72 cm
 Medida en la base / Mesure à la base / Measure at the base: 45ø cm.
 Apto para encimeras / Compatible avec plateaux / Compatible with table tops:
 80x80 - 90x90

1 cm. = 0,3937 In

**Alno H72**

Altura de la base / Hauteur du pied / Height of the base: 72 cm.
 Medida en la base / Mesure à la base / Measure at the base: 45ø cm.
 Apto para encimeras / Compatible avec plateaux / Compatible with table tops:
 80ø - 90ø - 100ø

1 cm. = 0,3937 In

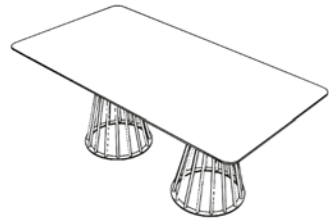
**Alno H72 x2**

Altura de la base / Hauteur du pied / Height of the base: 72 cm.
 Medida en la base / Mesure à la base / Measure at the base: 2 x 45ø cm.
 Apto para encimeras / Compatible avec plateaux / Compatible with table tops:
 150x80 - 160x80 - 180x80 - 200x80 - 220x80 - 240x80 150x90 - 160x90 - 180x90 - 200x90
 220x90 - 240x90 150x100 - 160x100 - 180x100 - 200x100 - 220x100 - 240x100

1 cm. = 0,3937 In

**Alno H72 x3**

Altura de la base / Hauteur du pied / Height of the base: 72 cm.
 Medida en la base / Mesure à la base / Measure at the base: 3 x 45ø cm.
 Apto para encimeras (2 piezas) / Compatible avec plateaux (2 pieces) Compatible with table tops
 (2 parts):
 280x80 - 320x80 - 360x80 - 400x80 280x90 - 320x90 - 360x90 - 400x90 280x100 - 320x100
 360x100 - 400x100

1 cm. = 0,3937 In

**Alno Big H72**

Altura de la base / Hauteur du pied / Height of the base: 72 cm.
 Medida en la base / Mesure à la base / Measure at the base: 70ø cm.
 Apto para encimeras / Compatible avec plateaux / Compatible with table tops:
 120x120 - 130x130 - 140x140

1 cm. = 0,3937 In

**Alno XL h72**

Altura de la base / Hauteur du pied / Height of the base: 72 cm.
 Medida en la base / Mesure à la base / Measure at the base: 70ø cm.
 Apto para encimeras / Compatible avec plateaux / Compatible with table tops:
 120ø - 130ø - 140ø - 150ø

1 cm. = 0,3937 In

**Alno Big H72 x2**

Altura de la base / Hauteur du pied / Height of the base: 72 cm.
 Medida en la base / Mesure à la base / Measure at the base: 2 x 70ø cm.
 Apto para encimeras / Compatible avec plateaux / Compatible with table tops:
 160x120 - 180x120 - 200x120 - 220x120 - 240x120

1 cm. = 0,3937 In

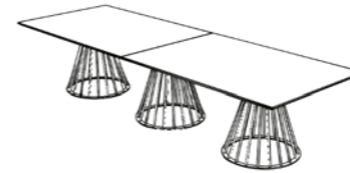
**Alno Big H72 x3**

Altura de la base / Hauteur du pied / Height of the base: 72 cm.
 Medida en la base / Mesure à la base / Measure at the base: 3 x 70ø cm.
 Apto para encimeras (2 piezas) / Compatible avec plateaux (2 pieces) Compatible with
 table tops (2 parts):
 280x120 - 320x120 - 360x120 - 400x120

1 cm. = 0,3937 In

**Alno High H107**

Altura de la base / Hauteur du pied / Height of the base: 107 cm.
 Medida en la base / Mesure à la base / Measure at the base: 45ø cm.
 Apto para encimeras / Compatible avec plateaux / Compatible with table tops:
 60x60 - 70x70

1 cm. = 0,3937 In

**Alno High H107**

Altura de la base / Hauteur du pied / Height of the base: 107 cm.
 Medida en la base / Mesure à la base / Measure at the base: 45ø cm.
 Apto para encimeras / Compatible avec plateaux / Compatible with table tops:
 60ø - 70ø

1 cm. = 0,3937 In

**Alno High H107 x2**

Altura de la base / Hauteur du pied / Height of the base: 107 cm.
 Medida en la base / Mesure à la base / Measure at the base: 2 x 45ø cm.
 Apto para encimeras / Compatible avec plateaux / Compatible with table tops:
 150x60 - 160x60 - 180x60 150x70 - 160x70 - 180x70

1 cm. = 0,3937 In

Becka

Indoor Solid Oak Plain Colors | Cover Ceramic Colors | Beech H-tres Colors | Multilam Liso/
Rustik/Olivato Colors | Laquered Ral Colors | (ver/voir/see pg 97-99)



Becka H72 - Roble Matt



Becka Rectangular H72
Roble Matt



Becka High H107 - Roble Matt

Becka

- Base para mesa de MDF con chapa de madera natural montado en folding de 12 caras. Reguladores en base. Montaje recomendado con encimeras cuadradas, rectangulares o redondas. Se sirve montado.

- Pied pour table de MDF avec placage en bois naturel monté en folding de 12 faces. Montage compatible avec les plateaux carrés, rectangulaires et rond. Pieds réglables. Livré monté. Vérins de réglage. Livré monté.

- MDF table base in natural wood veneer assembled by folding of 12 faces. Height regulators. Recommended for square, rectangular or round table tops. Delivered assembled.



Becka H72 - Cover ceramic 7044 - Encimera
Cover Ceramic 7044



Becka High H107 - Roble Clar - Encimera Cover
Marble Gold 9003



Becka Rectangular H72 - Roble Matt - Encimera Cover Marble Calacatta 9003

**Becka H72**

Altura de la base / Hauteur du pied / Height of the base: 72 cm.
 Medida en la base / Mesure à la base / Measure at the base: 40x40 cm.
 Apto para encimeras / Compatible avec plateaux / Compatible with table tops:
 80x80 - 90x90

1 cm. = 0,3937 In

**Becka H72**

Altura de la base / Hauteur du pied / Height of the base: 72 cm.
 Medida en la base / Mesure à la base / Measure at the base: 40x40 cm.
 Apto para encimeras / Compatible avec plateaux / Compatible with table tops:
 80ø - 90ø - 100ø

1 cm. = 0,3937 In

**Becka H72 x2**

Altura de la base / Hauteur du pied / Height of the base: 72 cm.
 Medida en la base / Mesure à la base / Measure at the base: 2x40x40 cm.
 Apto para encimeras / Compatible avec plateaux / Compatible with table tops:
 150x70 - 160x70 - 180x70 - 200x70 - 220x70 - 240x70 150x80 - 160x80 - 180x80 - 200x80
 220x80 - 240x80 150x90 - 160x90 - 180x90 - 200x90 - 220x90 - 240x90

1 cm. = 0,3937 In

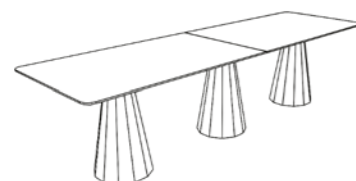
**Becka H72 x3**

Altura de la base / Hauteur du pied / Height of the base: 72 cm.
 Medida en la base / Mesure à la base / Measure at the base: 3x40x40 cm.
 Apto para encimeras (2 piezas) / Compatible avec plateaux (2 pieces) Compatible with table tops
 (2 parts):
 280x80 - 320x80 - 360x80 - 400x80 - 280x90 - 320x90 - 360x90 - 400x90

1 cm. = 0,3937 In

**Becka Rectangular H72**

Altura de la base / Hauteur du pied / Height of the base: 72 cm.
 Medida en la base / Mesure à la base / Measure at the base: 64x40 cm.
 Apto para encimeras / Compatible avec plateaux / Compatible with table tops:
 120x80 - 140x80 - 120x90 - 140x90

1 cm. = 0,3937 In

**Becka H72 Rectangular x2**

Altura de la base / Hauteur du pied / Height of the base: 72 cm.
 Medida en la base / Mesure à la base / Measure at the base: 2x64x40 cm.
 Apto para encimeras / Compatible avec plateaux / Compatible with table tops:
 150x100 - 160x100 - 180x100 - 200x100 - 220x100 - 240x100 150x120 - 160x120 - 180x120
 200x120 - 220x120 - 240x120

1 cm. = 0,3937 In

Técnico / Technique / Technical

**Becka Rectangular H72 x3**

Altura de la base / Hauteur du pied / Height of the base: 72 cm.
 Medida en la base / Mesure à la base / Measure at the base: 3 x 64 x 40 cm.
 Apto para encimeras (2 piezas) / Compatible avec plateaux (2 pieces) Compatible with table tops
 (2 parts):
 280x100 - 320x100 - 360x100 - 400x100 280x120 - 320x120 - 360x120 - 400x120

1 cm. = 0,3937 In

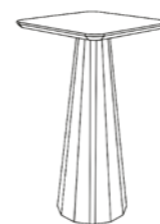
**Becka High H107**

Altura de la base / Hauteur du pied / Height of the base: 107 cm.
 Medida en la base / Mesure à la base / Measure at the base: 40x40 cm.
 Apto para encimeras / Compatible avec plateaux / Compatible with table tops:
 60x60 - 70x70

1 cm. = 0,3937 In

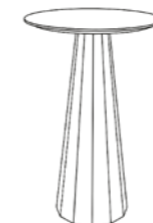
**Becka High H107**

Altura de la base / Hauteur du pied / Height of the base: 107 cm.
 Medida en la base / Mesure à la base / Measure at the base: 40 x 40 cm.
 Apto para encimeras / Compatible avec plateaux / Compatible with table tops:
 60ø - 70ø

1 cm. = 0,3937 In

**Becka High H107 x2**

Altura de la base / Hauteur du pied / Height of the base: 107 cm.
 Medida en la base / Mesure à la base / Measure at the base: 2 x 40 x 40 cm.
 Apto para encimeras / Compatible avec plateaux / Compatible with table tops:
 150x60 - 160x60 - 180x60 150x70 - 160x70 - 180x70

1 cm. = 0,3937 In



Four

Indoor Solid Oak Plain/Brush/Used Colors | Cover Ceramic Colors | Beech H-tres Colors |
Laquered Ral Colors | (ver/voir/see pg 97-99)



Four H72 RM - Haya Tinte negro



Four Rectangular H72 CB - Haya



Four H107 CB - Haya Matt

Four

- Base para mesa de 4 patas de madera maciza de haya o roble. Reguladores en patas. Montaje recomendado con encimeras cuadradas, rectangulares y redondas. Opción de pata recta o cónica con canto biselado o de media caña. Se sirve desmontado.
- Quatre pieds en chêne massif ou hêtre massif. Vérins de réglage. Montage compatible avec les tables carrées, rectangulaires et rondes. Option pieds droits ou coniques avec chant biseau ou arrondi. Livré démonté.
- Table base with 4 solid beech or oak legs. Height regulators. Recommended for square, rectangular or round table tops. Option of straight leg or conical leg with bevelled edge or bullnose edge. Delivered unassembled.



Four H72 RM - Haya Tinte Negro - Encimera Solid Micro Matt



Four Rectangular H72 CB - Haya Raw - Encimera Multilam Liso Haya Raw



Four Rectangular H72 CB - Cover Ceramic 7045 - Encimera Cover Ceramic 7045

Four

Patas rectas / Pieds droites / Straigh legs

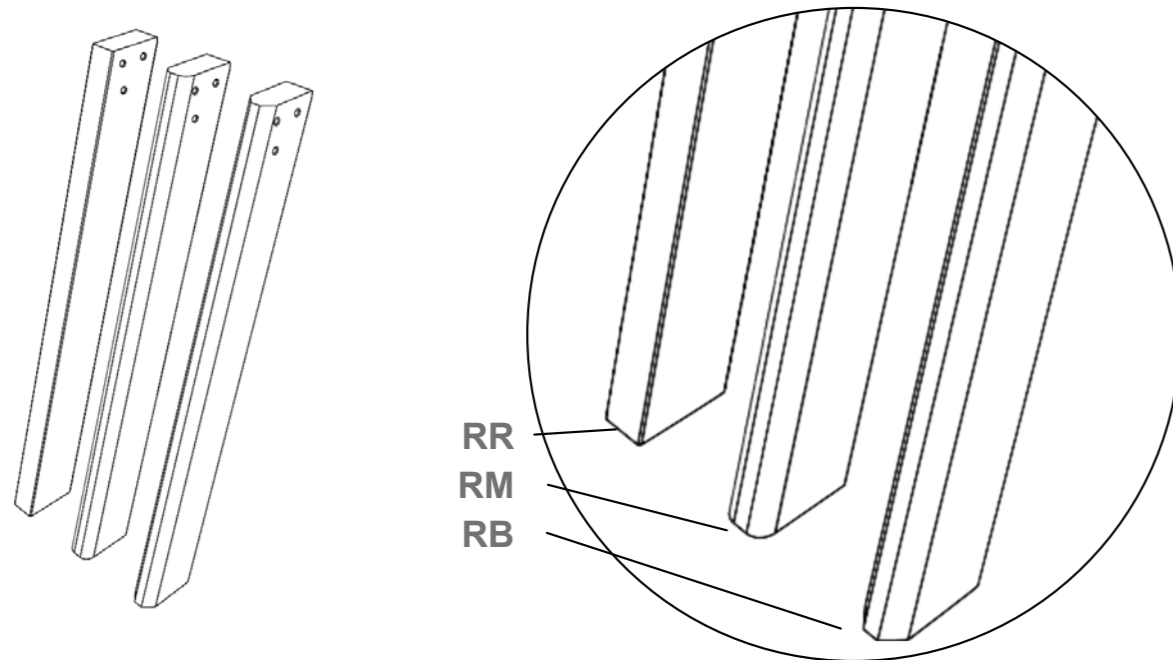

RR: Pata recta / Pied droit / Straigh leg

RM: Pata recta con media caña / Pied droite avec chant arrondi / Straigh leg with bullnose edge

RB: Pata recta con bisel / Pied droite avec chant biseau / Straigh leg with bevel edge

Patas cónicas / Pieds coniques / Tapered legs

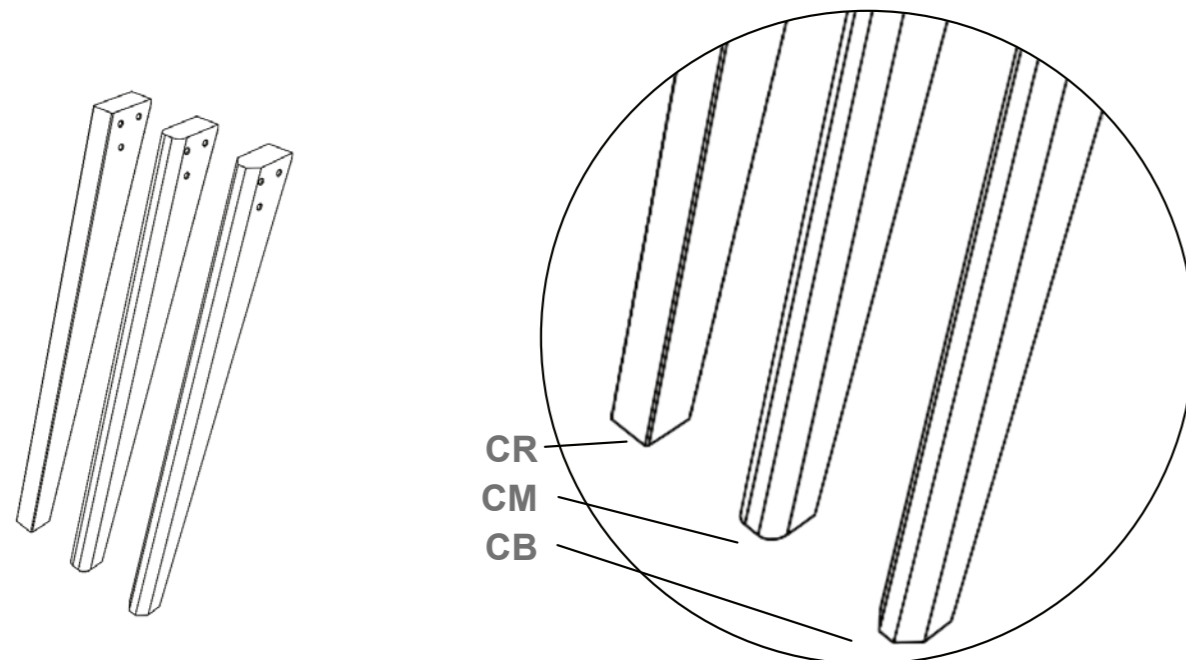

CR: Pata cónica / Pied conique / Tapered leg

CM: Pata cónica con media caña / Pied conique avec chant arrondi / Tapered leg with bullnose edge
CB: Pata cónica con bisel / Pied conique avec chant biseau / Tapered leg with bevel edge

Four

Técnico / Technique / Technical



Four H72

Altura de la base / Hauteur du pied / Height of the base: 72 cm.

Medida en la base / Mesure à la base / Measure at the base: 50x50, 64x64, 78x78 cm.

Apto para encimeras / Compatible avec plateaux / Compatible with table tops:

70x70 - 80x80 - 90x90 - 100x100

1 cm. = 0,3937 In



Four H72

Altura de la base / Hauteur du pied / Height of the base: 72 cm.

Medida en la base / Mesure à la base / Measure at the base: 50x50, 64x64, 78x78 cm.

Apto para encimeras / Compatible avec plateaux / Compatible with table tops:

70ø - 80ø - 90ø - 100ø - 110ø - 120ø

1 cm. = 0,3937 In



Four Rectangular H72

Altura de la base / Hauteur du pied / Height of the base: 72 cm.

Medida en la base / Mesure à la base / Measure at the base: L: 110 cm - W: 70 cm.

Apto para encimeras / Compatible avec plateaux / Compatible with table tops:

110x70 - 120x80

1 cm. = 0,3937 In



Four Doble H72

Altura de la base / Hauteur du pied / Height of the base: 72 cm.

Medida en la base / Mesure à la base / Measure at the base: 50{x} - 64{x} - 78{x} cm.

Apto para encimeras / Compatible avec plateaux / Compatible with table tops:

150x70 - 160x70 - 180x70 - 200x70 - 220x70 - 240x70 150x80 - 160x80 - 180x80 - 200x80
 220x80 - 240x80 150x90 - 160x90 - 180x90 - 200x90 - 220x90 - 240x90 150x100 - 160x100
 180x100 - 200x100 - 220x100 - 240x100

1 cm. = 0,3937 In



Four High H107

Altura de la base / Hauteur du pied / Height of the base: 107 cm.

Medida en la base / Mesure à la base / Measure at the base: 50 x 50 cm.

Apto para encimeras / Compatible avec plateaux / Compatible with table tops:

60x60 - 70x70

1 cm. = 0,3937 In



Four High H107

Altura de la base / Hauteur du pied / Height of the base: 107 cm.

Medida en la base / Mesure à la base / Measure at the base: 50 x 50 cm.

Apto para encimeras / Compatible avec plateaux / Compatible with table tops:

60ø - 70ø

1 cm. = 0,3937 In

Hexa

Indoor Solid Oak Plain Colors | Cover Ceramic Colors | Beech H-tres Colors | Multilam Liso/
Rustik/Olivato Colors | Laquered Ral Colors | (ver/voir/see pg 97-99)



Hexa H72 - Roble Matt



Hexa Rectangular H72 Roble Raw



Hexa High H107 - Olivatto Matt

Hexa

- Base para mesa de MDF con chapa de madera natural montado en folding de 6 caras. Reguladores en base. Montaje recomendado con encimeras cuadradas, rectangulares o redondas. Se sirve montado.

- Pied pour table de MDF avec placage en bois naturel monté en folding de 6 faces. Montage compatible avec les plateaux carrés, rectangulaires et rond. Pieds réglables. Livré monté. Vérins de réglage. Livré monté.

- MDF table base in natural wood veneer assembled by folding of 6 faces. Height regulators. Recommended for square, rectangular or round table tops. Delivered assembled.



Hexa H72 Roble Matt - Encimera Cover Ceramic Blanco 9003-1



Hexa High H107 Olivatto Matt - Encimera Cover Marble Musgo 6021

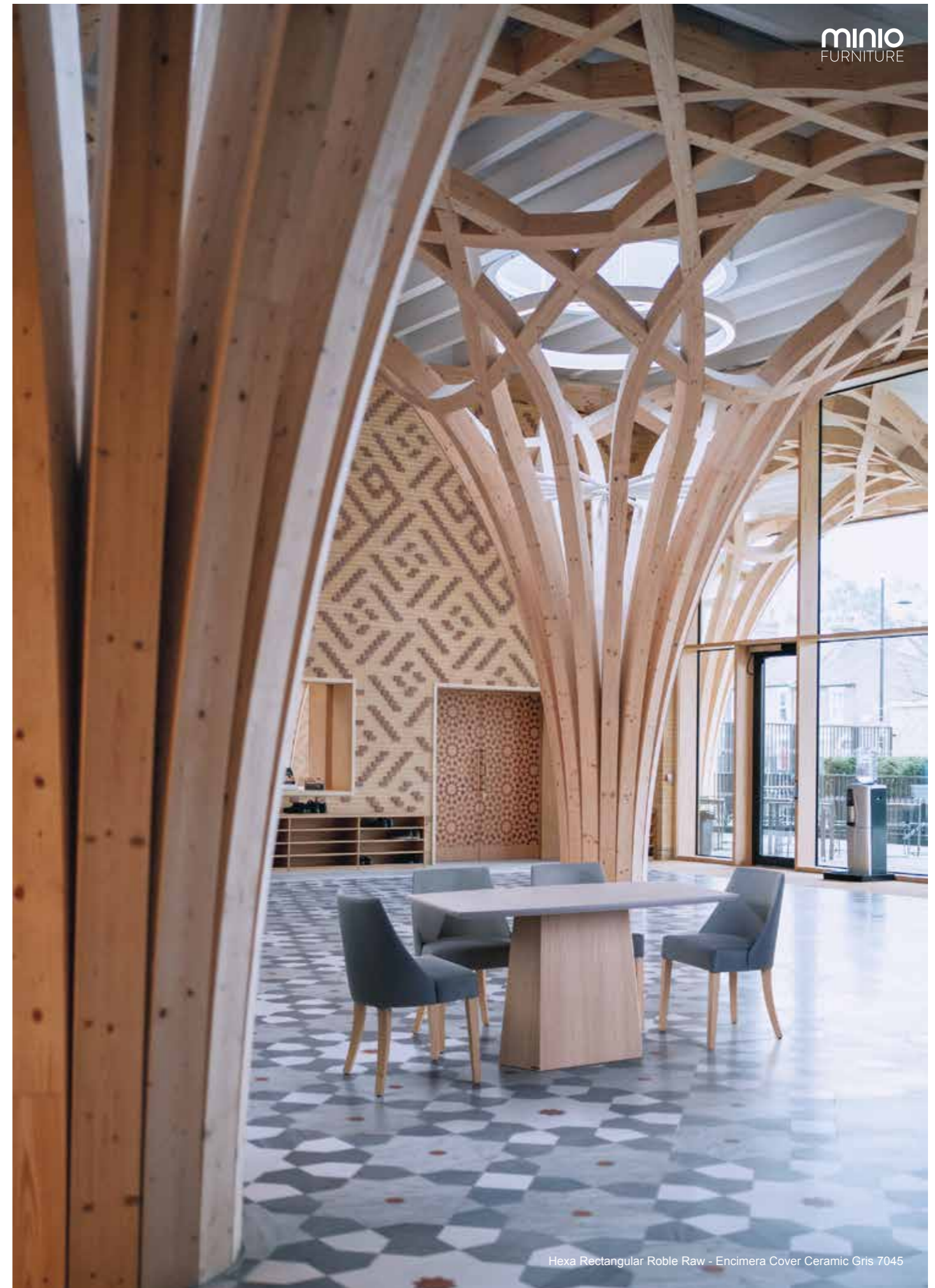

Hexa Rectangular Roble Raw - Encimera Cover Ceramic Gris 7045

Hexa H42

Altura de la base / Hauteur du pied / Height of the base: 42 cm.
 Medida en la base / Mesure à la base / Measure at the base: 45x39 cm.
 Apto para encimeras / Compatible avec plateaux / Compatible with table tops:
 60x60 - 70x70 - 80x80 - 90x90



1 cm. = 0,3937 In

Hexa H42

Altura de la base / Hauteur du pied / Height of the base: 42 cm.
 Medida en la base / Mesure à la base / Measure at the base: 45x39 cm.
 Apto para encimeras / Compatible avec plateaux / Compatible with table tops:
 60ø - 70ø - 80ø - 90ø - 100ø



1 cm. = 0,3937 In

Hexa H42 x2

Altura de la base / Hauteur du pied / Height of the base: 42 cm.
 Medida en la base / Mesure à la base / Measure at the base: 2 x 45x39 cm.
 Apto para encimeras / Compatible avec plateaux / Compatible with table tops:
 150x60 - 160x60 - 180x60 150x70 - 160x70 - 180x70

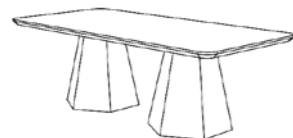

1 cm. = 0,3937 In

Hexa H72

Altura de la base / Hauteur du pied / Height of the base: 72 cm.
 Medida en la base / Mesure à la base / Measure at the base: 45x39 cm.
 Apto para encimeras / Compatible avec plateaux / Compatible with table tops:
 70x70 - 80x80 - 90x90

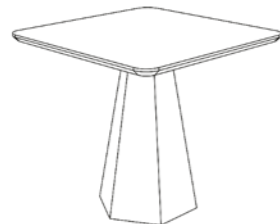

1 cm. = 0,3937 In

Hexa H72

Altura de la base / Hauteur du pied / Height of the base: 72 cm.
 Medida en la base / Mesure à la base / Measure at the base: 45x39 cm.
 Apto para encimeras / Compatible avec plateaux / Compatible with table tops:
 80ø - 90ø - 100ø



1 cm. = 0,3937 In

Becka Rectangular H72 x2

Altura de la base / Hauteur du pied / Height of the base: 72 cm.
 Medida en la base / Mesure à la base / Measure at the base: 70x39 cm.
 Apto para encimeras / Compatible avec plateaux / Compatible with table tops:
 120x80 - 140x80 - 120x90 - 140x90

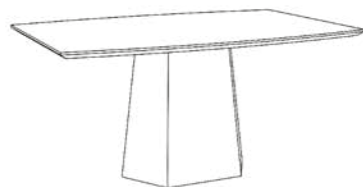

1 cm. = 0,3937 In

Hexa H72 x2

Altura de la base / Hauteur du pied / Height of the base: 72 cm.
 Medida en la base / Mesure à la base / Measure at the base: 2 x 45x39 cm.
 Apto para encimeras / Compatible avec plateaux / Compatible with table tops:
 150x70 - 160x70 - 180x70 - 200x70 - 220x70 - 240x70 150x80 - 160x80 - 180x80 - 200x80
 220x80 - 240x80 150x90 - 160x90 - 180x90 - 200x90 - 220x90 - 240x90

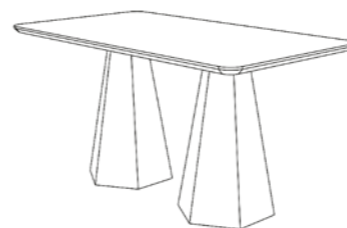

1 cm. = 0,3937 In

Hexa H72 x3

Altura de la base / Hauteur du pied / Height of the base: 72 cm.
 Medida en la base / Mesure à la base / Measure at the base: 3 x 45x39 cm.
 Apto para encimeras (2 piezas) / Compatible avec plateaux (2 pieces) Compatible with
 table tops (2 parts):
 280x80 - 320x80 - 360x80 - 400x80 280x90 - 320x90 - 360x90 - 400x90

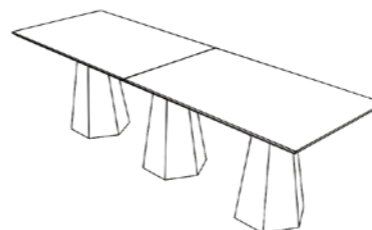

1 cm. = 0,3937 In

Hexa High H107

Altura de la base / Hauteur du pied / Height of the base: 107 cm.
 Medida en la base / Mesure à la base / Measure at the base: 45x39 cm.
 Apto para encimeras / Compatible avec plateaux / Compatible with table tops:
 60x60 - 70x70



1 cm. = 0,3937 In

Hexa High H107

Altura de la base / Hauteur du pied / Height of the base: 107 cm.
 Medida en la base / Mesure à la base / Measure at the base: 45x39 cm.
 Apto para encimeras / Compatible avec plateaux / Compatible with table tops:
 60ø - 70ø



1 cm. = 0,3937 In

Hexa High H107 x2

Altura de la base / Hauteur du pied / Height of the base: 107 cm.
 Medida en la base / Mesure à la base / Measure at the base: 2 x 45x39 cm.
 Apto para encimeras / Compatible avec plateaux / Compatible with table tops:
 150x60 - 160x60 - 180x60 150x70 - 160x70 - 180x70

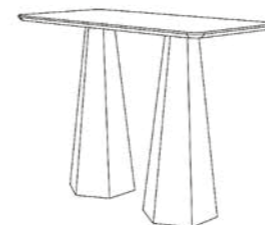

1 cm. = 0,3937 In

Lasso

Indoor Solid Oak Plain/Brush/Used Colors | Cover Ceramic Colors (ver/voir/see pg 97-99)

Lasso



Lasso H72 - Roble Raw

- Base para mesa en madera maciza de roble. Reguladores en base. Montaje recomendado con encimeras cuadradas, rectangulares y redondas. Se sirve montado.

- Pied pour table en bois de chêne massif. Vérins de réglage. Montage compatible avec les plateaux carrés, rectangulaires et rond. Pieds réglables. Livré monté.

- Solid oak table base. Height regulators. Recommended for square, rectangular and round table tops. Delivered assembled.



Lasso H72 Roble Matt - Encimera Solid Oak Matt



Lasso H72 Roble Matt - Encimera Solid Oak Matt

Técnico / Technique / Technical

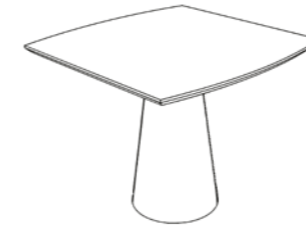

Lasso H72

Altura de la base / Hauteur du pied / Height of the base: 72 cm.

Medida en la base / Mesure à la base / Measure at the base: 40ø cm.

Apto para encimeras / Compatible avec plateaux / Compatible with table tops:
70x70 - 80x80 - 90x90

1 cm. = 0,3937 In



Lasso H72

Altura de la base / Hauteur du pied / Height of the base: 72 cm.

Medida en la base / Mesure à la base / Measure at the base: 40ø cm.

Apto para encimeras / Compatible avec plateaux / Compatible with table tops:
80ø - 90ø - 100ø

1 cm. = 0,3937 In



Lasso H72 x2

Altura de la base / Hauteur du pied / Height of the base: 72 cm.

Medida en la base / Mesure à la base / Measure at the base: 2 x 40ø cm.

Apto para encimeras / Compatible avec plateaux / Compatible with table tops:
150x70 - 160x70 - 180x70 - 200x70 - 220x70 - 240x70 150x80 - 160x80 - 180x80 - 200x80
220x80 - 240x80 150x90 - 160x90 - 180x90 - 200x90 - 220x90 - 240x90

1 cm. = 0,3937 In

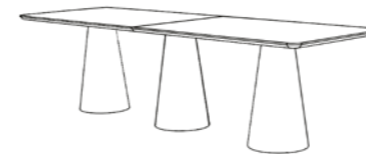

Lasso H72 x3

Altura de la base / Hauteur du pied / Height of the base: 72 cm.

Medida en la base / Mesure à la base / Measure at the base: 3 x 40ø cm.

Apto para encimeras (2 piezas) / Compatible avec plateaux (2 pieces) Compatible with table tops (2 parts):

280x80 - 320x80 - 360x80 - 400x80 280x90 - 320x90 - 360x90 - 400x90

1 cm. = 0,3937 In

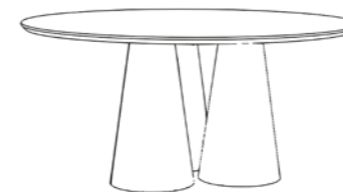

Lasso H72 x3 (Round)

Altura de la base / Hauteur du pied / Height of the base: 72 cm.

Medida en la base / Mesure à la base / Measure at the base: 3 x 40ø cm.

Apto para encimeras / Compatible avec plateaux / Compatible with table tops:
160ø - 180ø - 200ø

1 cm. = 0,3937 In

Line

Indoor Cover Ceramic Colors | Lacquered Ral Colors (ver/voir/see pg 97-99)



Line Square Low H42

Line Square H72

Line Square High 107

Line Square Big H72

Line Round Low H42

Line Round H72

Line Round High H107

Line Round Big H72

Line Rectangular Low H42

Line Rectangular H72

Line Rectangular High H107

Line

- Base para mesa de acero con columna de 60 mm de diámetro y base maciza de 8 mm (3,1") de espesor. Reguladores en base. Montaje recomendado con encimeras cuadradas, rectangulares o redondas. Se sirve desmontado.

- Pied pour table en acier avec colonne de Ø60 mm (23,6") et une base en macif de 8 mm (3,1") épaisseur, Montage recommandé pour les plateaux carrés, rectangulaires et ronds. Vérins de réglage. Livré démonté.

- Steel table base with 60 mm (23,6") diameter column and 8 mm (3,1") thick solid base. Height regulators. Recommended for square, rectangular or round table tops. Delivered unassembled.



Line Square H72 - Ral 9003TX - Encimera Cover Marble Calacatta 9003



Line Round High 107 - Ral 9005TX - Encimera Cover Ceramic 7044



Line Round Big H72 - Ral 9005TX - Encimera Solid Brus Matt



Line Square Low H42

Altura de la base / Hauteur du pied / Height of the base: 42 cm.
 Medida en la base / Mesure à la base / Measure at the base: 45x45 cm.
 Apto para encimeras / Compatible avec plateaux / Compatible with table tops:
 60x60 - 70x70 - 80x80 - 90x90



Line Rectangular Low H42

Altura de la base / Hauteur du pied / Height of the base: 42 cm.
 Medida en la base / Mesure à la base / Measure at the base: 80x40 cm.
 Apto para encimeras / Compatible avec plateaux / Compatible with table tops:
 100x60 - 110x70 - 120x70 - 120x80



Line Square H72

Altura de la base / Hauteur du pied / Height of the base: 72 cm.
 Medida en la base / Mesure à la base / Measure at the base: 45x45 cm.
 Apto para encimeras / Compatible avec plateaux / Compatible with table tops:
 60x60 - 70x70 - 80x80 - 90x90

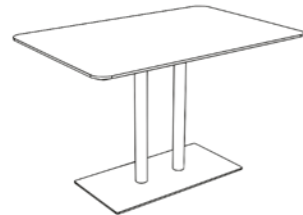

Line Rectangular H72

Altura de la base / Hauteur du pied / Height of the base: 72 cm.
 Medida en la base / Mesure à la base / Measure at the base: 80x40 cm.
 Apto para encimeras / Compatible avec plateaux / Compatible with table tops:
 100x60 - 110x70 - 120x70 - 120x80

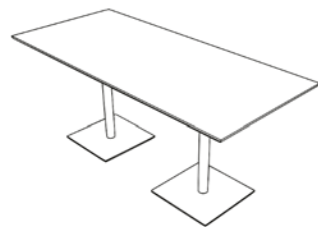

Line Square H72 x2

Altura de la base / Hauteur du pied / Height of the base: 72 cm.
 Medida en la base / Mesure à la base / Measure at the base: 2 x 45x45 cm.
 Apto para encimeras / Compatible avec plateaux / Compatible with table tops:
 150x70 - 160x70 - 180x70 - 200x70 - 220x70 - 240x70 150x80 - 160x80 - 180x80 - 200x80
 - 220x80 - 240x80 150x90 - 160x90 - 180x90 - 200x90 - 220x90 - 240x90

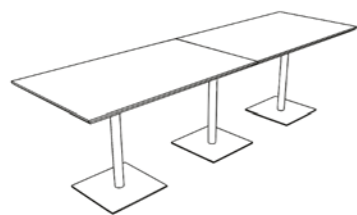

Line Square H72 x3

Altura de la base / Hauteur du pied / Height of the base: 72 cm.
 Medida en la base / Mesure à la base / Measure at the base: 3 x 45x45 cm.
 Apto para encimeras (2 piezas) / Compatible avec plateaux (2 pieces) Compatible with
 table tops (2 parts):
 280x80 - 320x80 - 360x80 - 400x80 280x90 - 320x90 - 360x90 - 400x90

Técnico / Technique / Technical



Line Square Big H72

Altura de la base / Hauteur du pied / Height of the base: 72 cm.
 Medida en la base / Mesure à la base / Measure at the base: 70x70 cm.
 Apto para encimeras / Compatible avec plateaux / Compatible with table tops:
 120x120 - 130x130 - 140x140

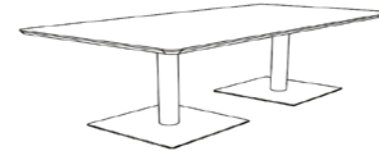

Line Square Big H72 x2

Altura de la base / Hauteur du pied / Height of the base: 72 cm.
 Medida en la base / Mesure à la base / Measure at the base: 2 x 70x70 cm..
 Apto para encimeras / Compatible avec plateaux / Compatible with table tops:
 160x120 - 180x120 - 200x120 - 220x120 - 240x120 160x140 - 180x140 - 200x140 -
 220x140 - 240x140

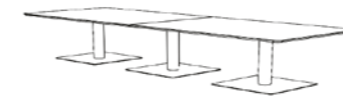

Line Square Big H72 x3

Altura de la base / Hauteur du pied / Height of the base: 72 cm.
 Medida en la base / Mesure à la base / Measure at the base: 3 x 70x70 cm.
 Apto para encimeras (2 piezas) / Compatible avec plateaux (2 pieces) Compatible with
 table tops (2 parts):
 280x120 - 320x120 - 360x120 - 400x120 280x140 - 320x140 - 360x140 - 400x140



Line Square High H107

Altura de la base / Hauteur du pied / Height of the base: 107 cm.
 Medida en la base / Mesure à la base / Measure at the base: 45x45 cm.
 Apto para encimeras / Compatible avec plateaux / Compatible with table tops:
 60x60 - 70x70

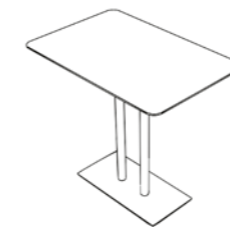

Line Rectangular High H107

Altura de la base / Hauteur du pied / Height of the base: 107 cm.
 Medida en la base / Mesure à la base / Measure at the base: 80x40 cm.
 Apto para encimeras / Compatible avec plateaux / Compatible with table tops:
 100x60 - 110x70 - 120x70 - 120x80



Line Square High H72 x2

Altura de la base / Hauteur du pied / Height of the base: 107 cm.
 Medida en la base / Mesure à la base / Measure at the base: 2 x 45x45 cm.
 Apto para encimeras / Compatible avec plateaux / Compatible with table tops:
 150x60 - 160x60 - 180x60 150x70 - 160x70 - 180x70

Nodo

Indoor Solid Oak Plain Colors | Cover Ceramic Colors | Beech H-tres Colors | Multilam Liso/
Rustik/Olivato Colors | Laquered Ral Colors | (ver/voir/see pg 97-99)



Nodo H72 Roble Matt

Nodo

- Base para mesa de MDF con chapa de madera natural montado en folding de 20 caras. Reguladores en base. Montaje recomendado con encimeras cuadradas, rectangulares o redondas. Se sirve montado.

- Pied pour table de MDF avec placage en bois naturel monté en folding de 20 faces. Montage compatible avec les plateaux carrés, rectangulaires et rond. Pieds réglables. Livré monté. Vérins de réglage. Livré monté.

- MDF table base in natural wood veneer assembled by folding of 20 faces. Height regulators. Recommended for square, rectangular or round table tops. Delivered assembled.



Nodo H72 - Roble Negro Esla - Encimera Multilam Liso Roble

Técnico / Technique / Technical



Nodo H72

Altura de la base / Hauteur du pied / Height of the base: 72 cm.

Medida en la base / Mesure à la base / Measure at the base: 60x60 cm.

Apto para encimeras / Compatible avec plateaux / Compatible with table tops:
120x120 - 130x130 - 140x140

1 cm. = 0,3937 In

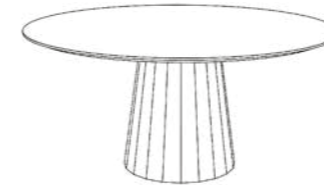

Nodo H72

Altura de la base / Hauteur du pied / Height of the base: 72 cm.

Medida en la base / Mesure à la base / Measure at the base: 60x60 cm.

Apto para encimeras / Compatible avec plateaux / Compatible with table tops:
120ø - 130ø - 140ø - 150ø

1 cm. = 0,3937 In



Nodo H72 X2

Altura de la base / Hauteur du pied / Height of the base: 72 cm.

Medida en la base / Mesure à la base / Measure at the base: 2 x 60x60 cm..

Apto para encimeras / Compatible avec plateaux / Compatible with table tops:
160x100 - 180x100 - 200x100 - 220x100 - 240x100 160x120 - 180x120 - 200x120
220x120 - 240x120

1 cm. = 0,3937 In

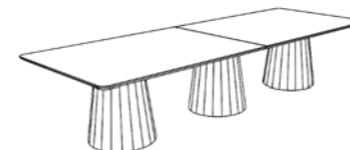

Nodo H72 X3

Altura de la base / Hauteur du pied / Height of the base: 72 cm.

Medida en la base / Mesure à la base / Measure at the base: 3 x 60x60 cm.

Apto para encimeras (2 piezas) / Compatible avec plateaux (2 pieces) Compatible with
table tops (2 parts):
280x100 - 320x100 - 360x100 - 400x100 280x120 - 320x120 - 360x120 - 400x120

1 cm. = 0,3937 In



Nodo H72 - Roble Negro Esla - Encimera Solid Brush Matt

Polo

Indoor Solid Oak Plain/Brush/Used Colors | Cover Ceramic Colors | Beech H-tres Colors |
Laquered Ral Colors | (ver/voir/see pg 97-99)



Polo Square H72 - Roble Matt

Polo Rectangular H72 - Roble Matt

Polo Big H72 - Roble Matt

Polo High H107 - Roble Matt

Polo

- Base para mesa de columna en madera maciza de haya o roble. Reguladores en patas. Montaje recomendado con encimeras cuadradas, rectangulares y redondas. Se sirve montado.

- Pied pour table de colonne en bois de chêne massif ou hêtre massif. Vérins de réglage. Montage compatible avec les plateaux carrés, rectangulaires et rond. Pieds réglables. Livré monté. Livré monté.

- Table base with a solid beech or oak column. Height regulators. Recommended for square, rectangular and round table tops. Delivered assembled.



Polo Rectangular H72 - Cover Ceramic Grafito 7012 - Encimera Cover Terrazzo Pierre Blanco 9003



Polor Square H72 - Roble Matt - Encimera Solid Brush Matt



Polo Square H72 - Haya Tinte negro - Encimera Solid Oak Matt



Polo Square H72

Altura de la base / Hauteur du pied / Height of the base: 72 cm.
 Medida en la base / Mesure à la base / Measure at the base: 48x48 cm.
 Apto para encimeras / Compatible avec plateaux / Compatible with table tops:
 70x70 - 80 80 - 90x90

1 cm. = 0,3937 In



Polo Square H72

Altura de la base / Hauteur du pied / Height of the base: 72 cm.
 Medida en la base / Mesure à la base / Measure at the base: 48x48 cm.
 Apto para encimeras / Convient pour les plateaux / Suitable for table tops:
 70ø - 80ø - 90ø - 100ø

1 cm. = 0,3937 In



Polo Rectangular H72

Altura de la base / Hauteur du pied / Height of the base: 72 cm.
 Medida en la base / Mesure à la base / Measure at the base: 95x65 cm.
 Apto para encimeras / Compatible avec plateaux / Compatible with table tops:
 110x70 - 120x80

1 cm. = 0,3937 In



Polo Square H72 x2

Altura de la base / Hauteur du pied / Height of the base: 00 cm.
 Medida en la base / Mesure à la base / Measure at the base: 2 x 48x48 cm.
 Apto para encimeras / Compatible avec plateaux / Compatible with table tops:
 150x70 - 160x70 - 180x70 - 200x70 - 220x70 - 240x70 150x80 - 160x80 - 180x80 - 200x80
 220x80 - 240x80 150x90 - 160x90 - 180x90 - 200x90 - 220x90 - 240x90

1 cm. = 0,3937 In



Polo Square H72 x3

Altura de la base / Hauteur du pied / Height of the base: 72 cm.
 Medida en la base / Mesure à la base / Measure at the base: 3 x 48x48 cm.
 Apto para encimeras (2 piezas) / Compatible avec plateaux (2 pieces) Compatible with
 table tops (2 parts):
 280x80 - 320x80 - 360x80 - 400x80 280x90 - 320x90 - 360x90 - 400x90

1 cm. = 0,3937 In



Polo Big H72

Altura de la base / Hauteur du pied / Height of the base: 72 cm.
 Medida en la base / Mesure à la base / Measure at the base: 70x70 cm.
 Apto para encimeras / Compatible avec plateaux / Compatible with table tops:
 100x100 - 120x120 - 140x140

1 cm. = 0,3937 In

Técnico / Technique / Technical



Polo Big H72

Altura de la base / Hauteur du pied / Height of the base: 72 cm.
 Medida en la base / Mesure à la base / Measure at the base: 70x70 cm.
 Apto para encimeras / Compatible avec plateaux / Compatible with table tops:
 110ø - 120ø - 130ø - 140ø - 150ø

1 cm. = 0,3937 In



Polo Big H72 x2

Altura de la base / Hauteur du pied / Height of the base: 72 cm.
 Medida en la base / Mesure à la base / Measure at the base: 2 x 70x70 cm..
 Apto para encimeras / Compatible avec plateaux / Compatible with table tops:
 160x100 - 180x100 - 200x100 - 220x100 - 240x100 160x120 - 180x120 - 200x120 -
 220x120 - 240x120

1 cm. = 0,3937 In



Polo Big H72 x3

Altura de la base / Hauteur du pied / Height of the base: 72 cm.
 Medida en la base / Mesure à la base / Measure at the base: 3 x 70x70 cm.
 Apto para encimeras (2 piezas) / Compatible avec plateaux (2 pieces) Compatible with
 table tops (2 parts):
 280x100 - 320x100 - 360x100 - 400x100 280x120 - 320x120 - 360x120 - 400x120

1 cm. = 0,3937 In



Polo High H107

Altura de la base / Hauteur du pied / Height of the base: 107 cm.
 Medida en la base / Mesure à la base / Measure at the base: 48x48 cm.
 Apto para encimeras / Compatible avec plateaux / Compatible with table tops:
 60x60 - 70x70

1 cm. = 0,3937 In



Polo High H107

Altura de la base / Hauteur du pied / Height of the base: 107 cm.
 Medida en la base / Mesure à la base / Measure at the base: 48x48 cm.
 Apto para encimeras / Convient pour les plateaux / Suitable for table tops:
 60ø - 70ø

1 cm. = 0,3937 In



Polo High H107 x2

Altura de la base / Hauteur du pied / Height of the base: 107 cm.
 Medida en la base / Mesure à la base / Measure at the base: 2 x 48x48 cm.
 Apto para encimeras / Compatible avec plateaux / Compatible with table tops:
 150x60 - 160x60 - 180x60 150x70 - 160x70 - 180x70

1 cm. = 0,3937 In

Trio

Indoor Solid Oak Plain/Brush/Used Colors | Cover Ceramic Colors | Beech H-tres Colors |
Laquered Ral Colors | (ver/voir/see pg 97-99)



Trio H72 RB - Roble Matt

Trio High H107 CB - Haya Raw

Trio

- Base para mesa de 3 patas de madera maciza de haya o roble. Montaje recomendado con encimeras redondas. Opción de pata recta o cónica con canto biselado o de media caña. Se sirve desmontado.

- Pied pour table a 3 pattes en bois massif en chêne ou en hêtre massif. Montage compatible avec les tables rondes. Option de pied droite ou conique avec chant biseau ou arrondi. Livré démonté.

- Table base with 3 solid beech or oak legs. Recommended for round table tops. Option of straight leg or conical leg with bevelled edge or bullnose edge. Delivered unassembled.



Trio H72 RB - Roble Matt - Encimera Cover Ceramic 9003-1



Trio H72 RR - Roble Matt - Encimera Multilam Ash Negro Esla

Trio

Patas rectas / Pieds droites / Straigh legs

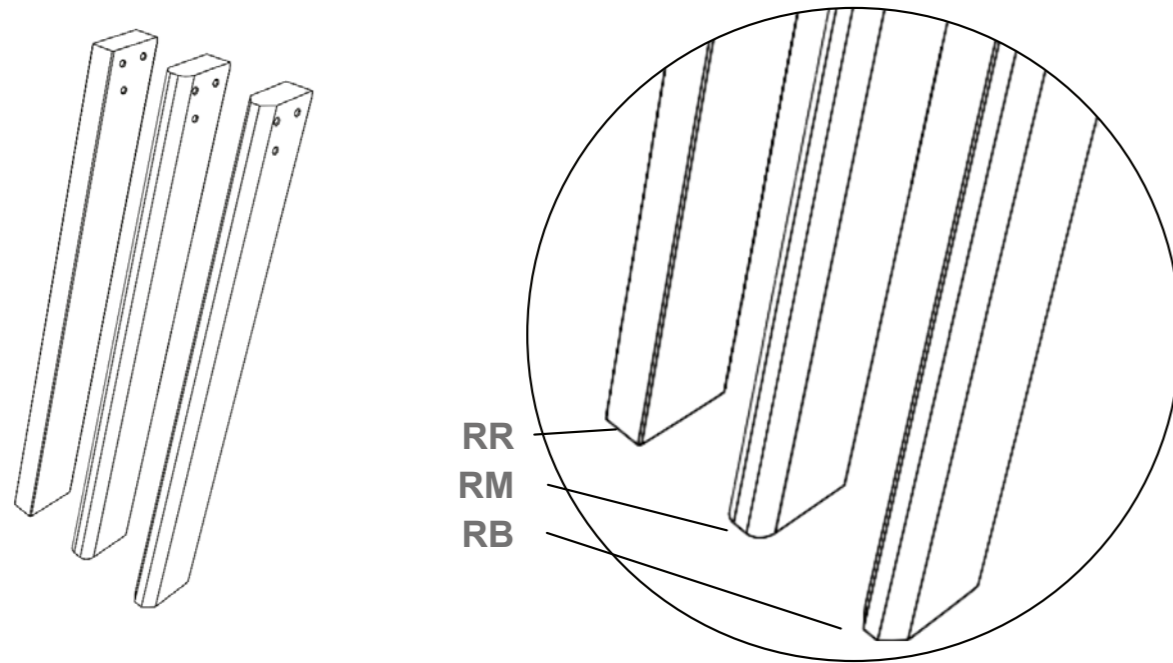

RR: Pata recta / Pied droit / Straigh leg

RM: Pata recta con media caña / Pied droite avec chant arrondi / Straigh leg with bullnose edge

RB: Pata recta con bisel / Pied droite avec chant biseau / Straigh leg with bevel edge

Patas cónicas / Pieds coniques / Tapered legs

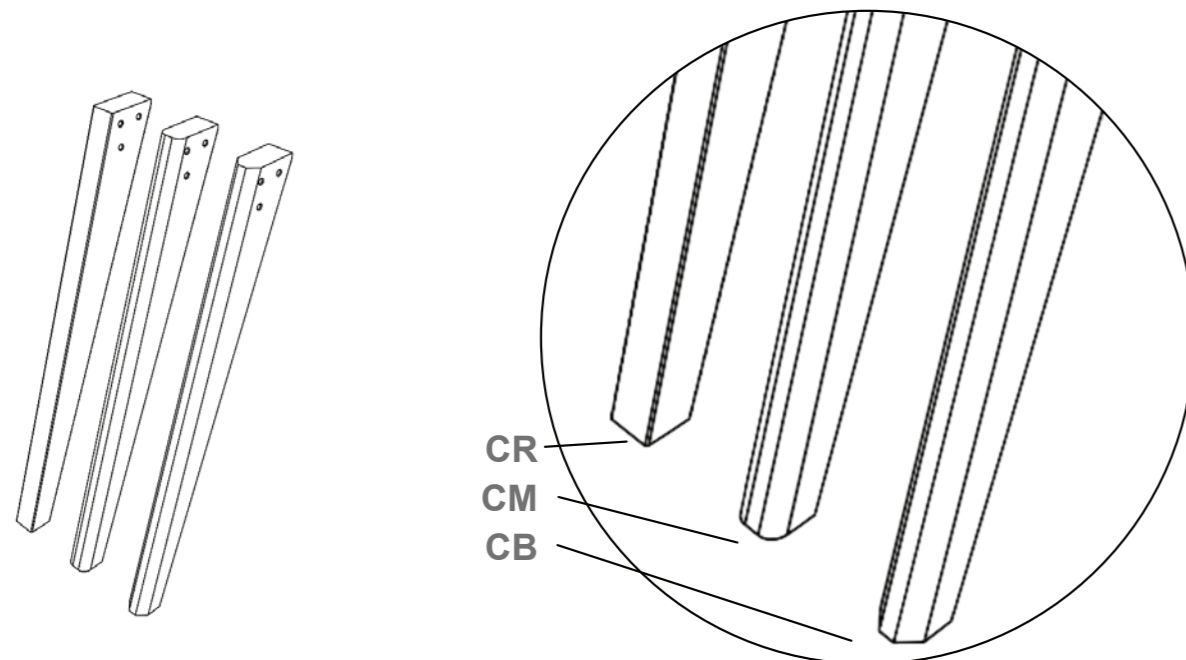

CR: Pata cónica / Pied conique / Tapered leg

CM: Pata cónica con media caña / Pied conique avec chant arrondi / Tapered leg with bullnose edge
CB: Pata cónica con bisel / Pied conique avec chant biseau / Tapered leg with bevel edge

Trio

Técnico / Technique / Technical



Trio H72

Altura de la base / Hauteur du pied / Height of the base: 72 cm.

Medida en la base / Mesure à la base / Measure at the base: r35, r45, r55 cm.

Apto para encimeras / Compatible avec plateaux / Compatible with table tops:

70ø - 80ø - 90ø - 100ø - 110ø - 120ø

1 cm. = 0,3937 In



Trio H72 x2

Altura de la base / Hauteur du pied / Height of the base: 72 cm.

Medida en la base / Mesure à la base / Measure at the base: r35, r45, r55 cm.

Apto para encimeras / Compatible avec plateaux / Compatible with table tops:

150x70 - 160x70 - 180x70 - 200x70 - 220x70 - 240x70 150x80 - 160x80 - 180x80 - 200x80

220x80 - 240x80 150x90 - 160x90 - 180x90 - 200x90 - 220x90 - 240x90

1 cm. = 0,3937 In



Trio High H107

Altura de la base / Hauteur du pied / Height of the base: 107 cm.

Medida en la base / Mesure à la base / Measure at the base: r35 cm.

Apto para encimeras / Compatible avec plateaux / Compatible with table tops:

60ø - 70ø

1 cm. = 0,3937 In



Trio High H107 x2

Altura de la base / Hauteur du pied / Height of the base: 72 cm.

Medida en la base / Mesure à la base / Measure at the base: r35 cm.

Apto para encimeras / Compatible avec plateaux / Compatible with table tops:

150x60 - 160x60 - 180x60 150x70 - 160x70 - 180x70

1 cm. = 0,3937 In

Multilam Mite Outdoor

Outdoor



Mite Outdoor: Clar ST - RT



Mite Outdoor: Clar ST - RT

Multilam Mite

- Encimera de multilaminado de abedul barnizado. Envejecido a mano.
- Plateau en multiplis de bouleau verni. Vieilli à la main
- Table top in varnished birch plywood. Hand aged.

Medidas estándar / Mesures standard / Standard measures

60x60 - 70x70 - 80x80 - 90x90 110x70 - 120x80 - 140x90
60Ø- 70Ø- 80Ø

23,6x23,6 - 27,5x27,5 - 31,5x31,5 - 35,4x35,4 - 43,3x27,5 - 47,2x31,5 - 140x35,4
23,6Ø - 27,5Ø - 31,5Ø - 35,4Ø



Mite Outdoor: Tintor ST - RT



Mite Blanc



Mite Natur



Mite Clar



Mite Champ



Mite Tintor



Mite Ama

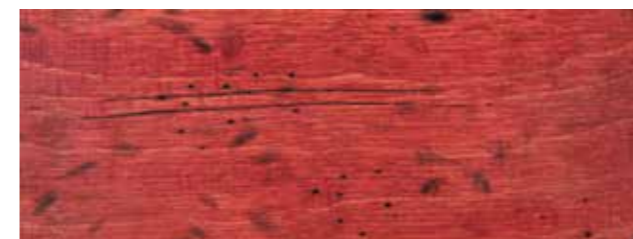

Mite Roj



Mite Neg

Forma - Forme - Shape

ST

- Encimera con 4 lados rectos.
- Plateau à 4 côtés droits
- Table top with 4 straight sides.



RND

- Encimera redonda.
- Plateau rond.
- Round table top.

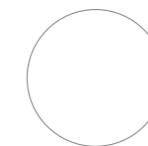

Canto - Chant - Edge

RT

- Canto recto standard.
- Chant droit standard.
- Standard straight edges.

B45

- Canto con bisel a 45° y plano de 10 mm.
- Chant avec biseau de 45° et droit de 10 mm.
- 45° chamfer edges and 10 mm face.

- Las muestras de color que se ven en las imágenes son de carácter orientativo. Las imágenes pueden diferir del tono real del producto final.
- Une image vue sur un écran (ordinateur, tablette, smartphone, etc.) ou sur un document imprimé peut faire varier la couleur/le ton des matériaux.
- Printed color samples are for guidance only. They may differ from the actual tone of the final product.

S200

Outdoor Black Color | Lacquered Ral Colors (ver/voir/see pg 97-99)

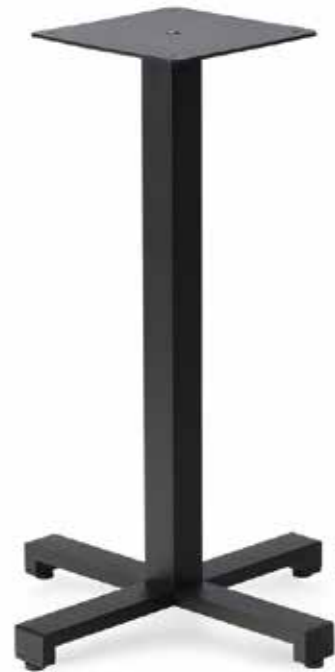

200 Ral 9005

S200 Outdoor

- Pie de aluminio pintado para uso en interior y exterior.
- Columna de 50x50 mm y base de perfil de 50x20 mm.
- Reguladores en las patas y sistema antigiro.
- Se entrega desmontado.

- Pied en aluminium peint pour un usage intérieur et extérieur.
- Colonne de 50x50 mm et base en profil de 50x20mm.
- Vérins de réglage de la hauteur et système anti rotation.
- Livré démonté.

- Painted aluminium leg for indoor and outdoor use.
- 50x50 mm column and 50x20 mm base tube.
- Height regulators and anti-spin systems.
- Delivered unassembled.

Medidas estándar / Mesures standard / Standard measures

1 cm. = 0,3937 In.

S200 Outdoor H72 - Base 47 x 47 x h72 cm.

Encimeras / Plateaux / Table tops:

60x60 - 70x70 - 80x80 - 90x90 / 60ø - 70ø - 80ø - 90ø

S300

Outdoor Black Color | Lacquered Ral Colors (ver/voir/see pg 97-99)



300 Plata

S300 Outdoor

- Pie de aluminio pintado para uso en interior y exterior.
- Base maciza de 2 cm. de grosor.
- Reguladores en las patas y sistema antigiro.
- Se entrega desmontado.

- Pied en aluminium peint pour un usage intérieur et extérieur.
- Base de 2 cm. d'épaisseur.
- Vérins de réglage de la hauteur et système anti rotation.
- Livré démonté.

- Painted aluminium leg for indoor and outdoor use.
- 2 cm. solid base.
- Height regulators and anti-spin systems.
- Delivered unassembled.

Medidas estándar / Mesures standard / Standard measures

1 cm. = 0,3937 In.

S300 Outdoor Round Small H72 - Base 40ø x h72.5 cm.

Encimeras / Plateaux / Table tops: 60ø - 70ø

S301 Outdoor Round H72 - Base 45ø x h72.5 cm.

Encimeras / Plateaux / Table tops: 60ø - 70ø - 80ø - 90ø

S302 Outdoor Round Big H72 - Base 60ø x h72.5 cm.

Encimeras / Plateaux / Table tops: 100ø - 120ø

S303 Outdoor Round Small High H109,5 - Base 40ø x h109.5 cm.

Encimeras / Plateaux / Table tops: 60ø

S304 Outdoor Round High H109,5 - Base 45ø x h109.5 cm.

Encimeras / Plateaux / Table tops: 60ø - 70ø

S305 Outdoor Round Big High H109,5 - Base 60ø x h109.5 cm.

Encimeras / Plateaux / Table tops: 70ø - 80ø - 90ø

S400

Outdoor Black Color | Lacquered Ral Colors (ver/voir/see pg 97-99)



411 Ral 9005

S400 Outdoor

- Pie de aluminio fundido pintado para uso en exterior.
- Reguladores en patas.
- Se entrega desmontado.

- Pied en aluminium forgé peint pour un usage extérieur.
- Vérins de réglage de la hauteur.
- Livré démonté.

- Painted cast aluminium leg for outdoor use.
- Height regulators.
- Delivered unassembled.

Medidas estándar / Mesures standard / Standard measures

1 cm. = 0,3937 In.

S411 Outdoor H72 - Base 54 x 54 x h72 cm.
Encimeras / Plateaux / Table tops: 60x60 - 70x70 - 80x80 / 60ø - 70ø - 80ø

S421 Outdoor H72 - Base 54 x 54 x h108 cm.
Encimeras / Plateaux / Table tops: 60x60 / 60ø - 70ø

S410 Outdoor H72 - Base 80 x 48 x h72 cm.
Encimeras / Plateaux / Table tops: 100x60 - 110x70 - 120x70 - 120x80



421 Ral 9005



410 Ral 9005

S800

Outdoor Black Color | Lacquered Ral Colors (ver/voir/see pg 97-99)



S800 Outdoor

- Pie de aluminio pintado para uso en interior y exterior.
- Base maciza de 2 cm de grosor.
- Reguladores en las patas y sistema antigiro.
- Se entrega desmontado.

- Pied en aluminium peint pour un usage intérieur et extérieur.
- Base de 2 cm d'épaisseur.
- Vérins de réglage de la hauteur et système anti rotation.
- Livré démonté.

- Painted aluminium leg for indoor and outdoor use.
- 2 cm solid base.
- Height regulators and anti-spin systems.
- Delivered unassembled.

Medidas estándar / Mesures standard / Standard measures

1 cm. = 0,3937 In.

S810 Outdoor Square Small H72 - Base 40 x 40 x h72.5 cm.
Encimeras / Plateaux / Table tops: 60x60 - 70x70 - 80x80

S811 Outdoor Square H72 - Base 45 x 45 x h72.5 cm.
Encimeras / Plateaux / Table tops: 60x60 - 70x70 - 80x80

S812 Outdoor Rectangular H72 - Base 70 x 40 x h72.5 cm.
Encimeras / Plateaux / Table tops: 100x60 - 110x70 - 120x70

S813 Outdoor Square Small High H109,5 - Base 40 x 40 x h109.5 cm.
Encimeras / Plateaux / Table tops: 60x60

S814 Outdoor Square High H109,5 - Base 45 x 45 x h109.5 cm.
Encimeras / Plateaux / Table tops: 60x60 - 70x70

S815 Outdoor Rectangular High H109,5 - Base 70 x 40 x h109.5 cm.
Encimeras / Plateaux / Table tops: 100x60 - 110x70 - 120x70

S900

Outdoor Black Color | Lacquered Ral Colors (ver/voir/see pg 97-99)



411 Ral 9005

S900 Outdoor

- Pie de aluminio pintado para uso en interior y exterior.
- Columna de 70x70 mm y base de perfil de 50x20 mm.
- Mecanismo de encimera abatible.
- Reguladores en las patas y sistema antigiro.
- Se entrega desmontado.

- Pied en aluminium peint pour un usage intérieur et extérieur.
- Colonne de 70x70 mm et base d'un profil de 50x20mm.
- Mécanisme de plateau pliable.
- Vérins de réglage de la hauteur et système anti rotation.
- Livré démonté.

- Painted aluminium leg for indoor and outdoor use.
- 70x70 mm column and 50x20 mm base tube.
- Hinged table top mechanism.
- Height regulators and anti-spin systems.
- Delivered unassembled.

Medidas estándar / Mesures standard / Standard measures

1 cm. = 0,3937 In.

S900 Outdoor H72 - Base 47,4 x 47,4 x h72 cm.

Encimeras / Plateaux / Table tops: 60x60 - 70x70 - 80x80 - 90x90

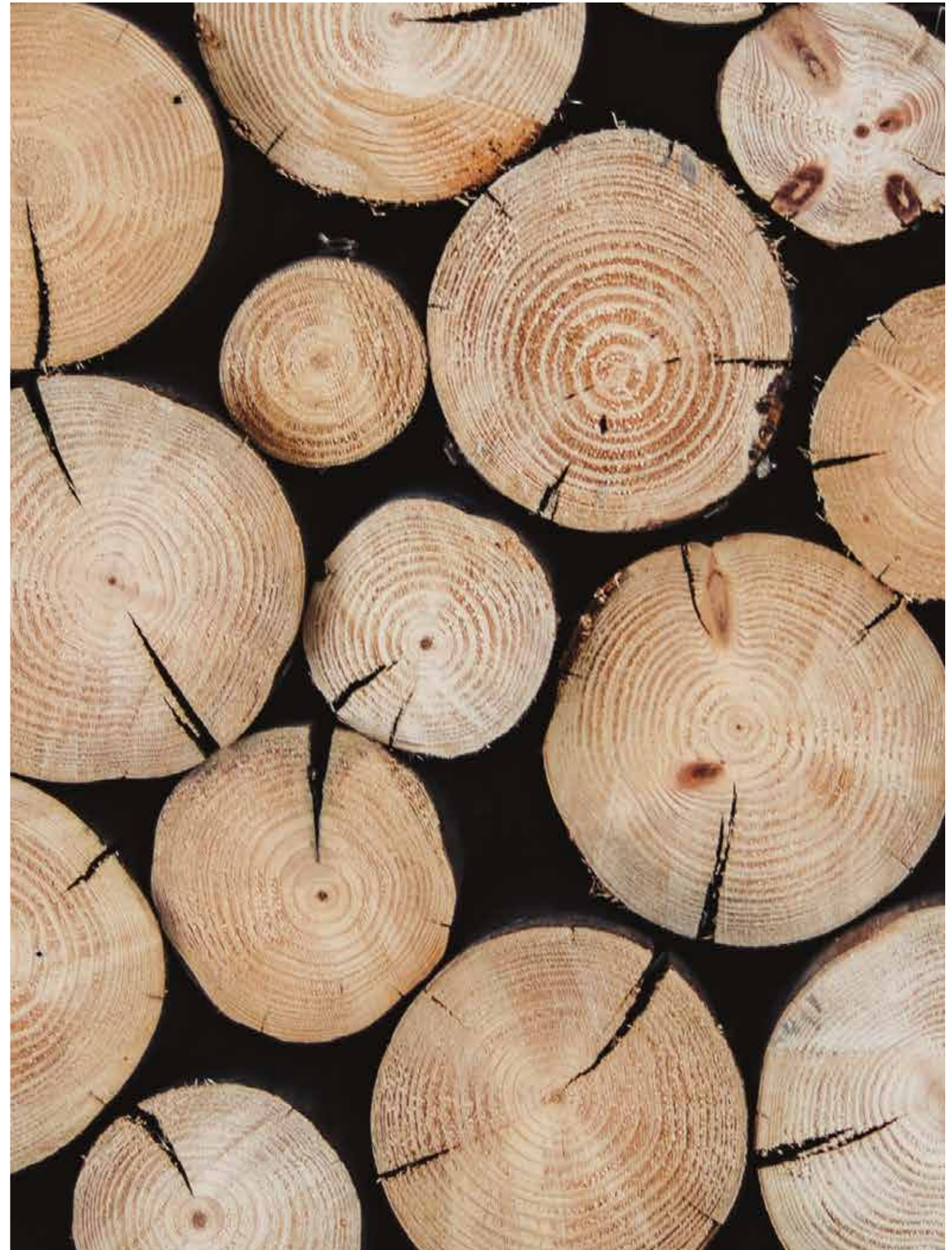

Minio Seat Finishes

Standard wood colours

Beech wood



C509 Beech Supermate C564 Beech Supermate C26 Beech Supermate C20 Beech Supermate



C102 Beech Supermate C453 Beech C63 Beech C455 Beech

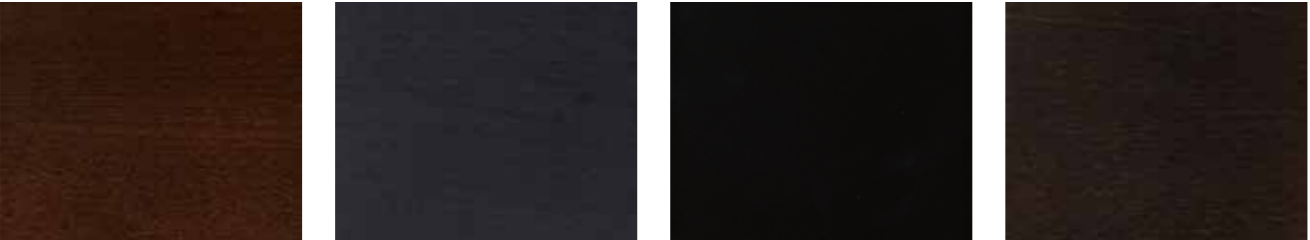

C64 Beech C118 Beech C46 Beech C31 Beech

Ash wood



C544 Ash Supermate C704 Ash C112 Ash

Rope colours (Eve chair pg 19)



T0005 Black



T0004 Green



T0006 Beige



T0003 Gray

Wicker options

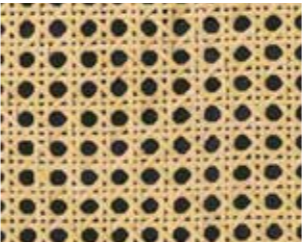

Traditional Cane Wicker

La paja es un producto natural, por lo que tiene particularidades naturales como astillado de hilo, rotura de paja, cambio en la sombra con el tiempo, y diferentes matices en el mismo lote de paja, entre otros.

La paille est un produit naturel, il a donc des particularités naturelles telles que l'écaillage du fil, le bris de paille, le changement de l'ombre au fil du temps et différentes nuances dans le même lot de paille, entre autres.

Straw is a natural product, so it has natural particularities such as thread chipping, straw breakage, change in the shade over time, and different shades in the same batch of straw, among others.

Glides options



Standard glides: White plastic
Cod. DES04
Suelo ceramico | Sols en carreaux | Tiles Flooring



Standard glides: Brown Plastic
Cod. DES05
Suelo ceramico | Sols en carreaux | Tiles Flooring



Special Glides: White Plastic & Felt (+2%)
Cod. DES01
Suelo madera/parquet | Parquet | Parquet flooring



Special Glides (+2%)
Cod. DES02
Suelo madera/parquet | Parquet | Parquet flooring



Special Glides: Plastic & metal (+3%)
Cod. DES03
Suelo moqueta | Moquette | Carpet flooring



Special Glides: Teflon with nail (+3%)
Cod. DES33
Suelo Linoleum | Linoléum | Linoleum Flooring



Special Glides: Teflon with nail (+3%)
Cod. DES33
Suelo Linoleum | Linoléum | Linoleum Flooring



Special Glides: Black plastic (+3%)
Cod. DES77
Suelo madera/parquet | Parquet | Parquet flooring

Minio Tables Finishes

● Colores standard del muestrario | Couleurs standard de l'échantillon | Standard colors of the sample book.

○ Colores no standard fuera del muestrario. | Couleurs non standard en dehors de l'échantillon. | Non-standard colors outside the sample book.

Solid Oak Plain



Raw



Matt



Clar



Tintor

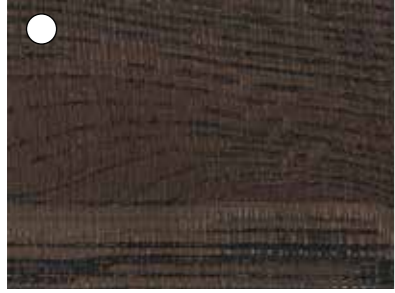

Esla

Solid Oak Brushed



Raw



Matt



Esla

○
 Mismos colores que Solid Oak Plain pero madera cepillada y con nudos |
 Mêmes couleurs que Solid Oak Plain mais bois brossé et noueux |
 Same colors as Solid Oak Plain but brushed and knotted wood

Solid Oak Used



Natur



Champ

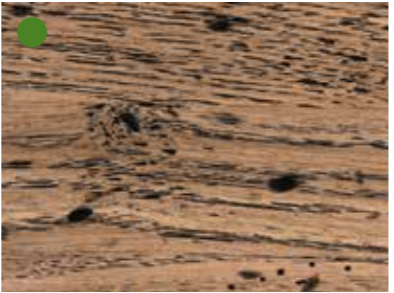

Clar

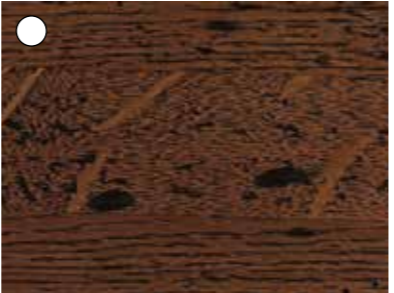

Tintor

Solid Pine Used



Blanc



Clar



Tintor



Roj



Natur



Champ



Ama



Neg

Cover Ceramic

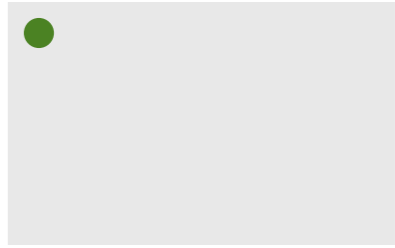

Blanco 9003-1



Crema 1013



Piedra 7044



Barro 7030



Gris 7045



Grafito 7012

Minio Table Finishes

● Colores standard del muestrario | Couleurs standard de l'échantillon | Standard colors of the sample book.

○ Colores no standard fuera del muestrario. | Couleurs non standard en dehors de l'échantillon. | Non-standard colors outside the sample book.

Cover Marble



Calacatta 9003



Crema 9003



Blanco 9003

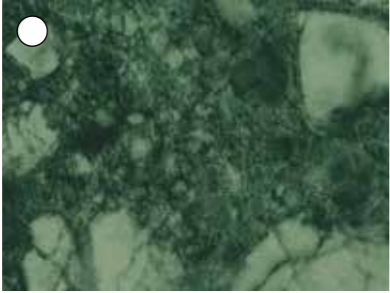

Musgo 6023

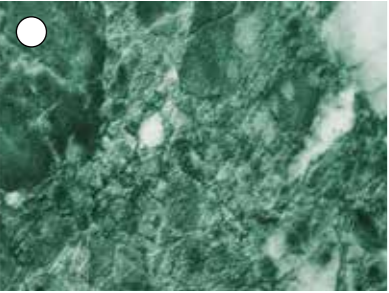

Musgo 9003



Mármol negro

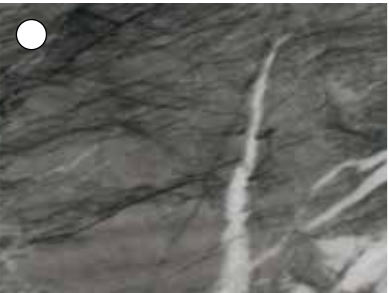

Mármol gris



Travertino Romano 9003



Gold 9003

H-Tres CH Beech/RB Oak



Tinte 160



Tinte 165



Tinte 163



Tinte 501



Multilam Liso



Raw



Matt



Clar



Matt



Tintor

Multilam Rustik



Raw



Matt

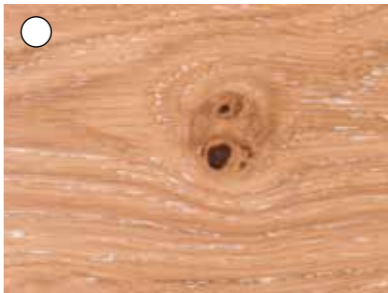

Blanqueado



Clar



Tintor



Esla

○ Mismos colores que Multilam Liso pero madera con nudos | Mêmes couleurs que Multilam Liso mais bois avec noeuds. | Same colors as Multilam Liso but wood with knots.

Minio Table Finishes

● Colores standard del muestrario | Couleurs standard de l'échantillon | Standard colors of the sample book.

○ Colores no standard fuera del muestrario. | Couleurs non standard en dehors de l'échantillon. | Non-standard colors outside the sample book.

Multilam Olivato



Raw



Matt



Claro



Tintor

Multilam Mite Outdoor



Mite Blanc



Mite Claro



Mite Tintor



Mite Rojo

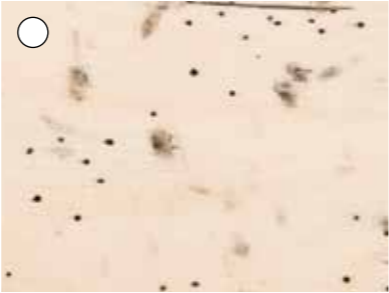

Mite Natur



Mite Champ



Mite Amap



Mite Negro

Lacquered Ral Colors

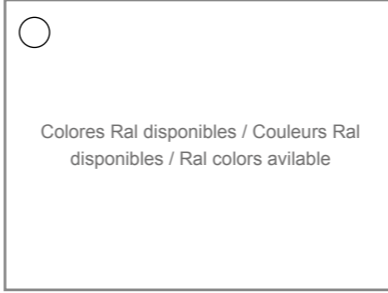

Information

1. **Ámbito de uso.**

Las encimeras y bases del catálogo de Minio están indicadas para su uso en interiores. El uso en el exterior podría provocar daños estéticos prematuros dependiendo de la intensidad de la exposición a los agentes atmosféricos y de cómo se actúe tras cada ciclo de exposición a dichos elementos.

1. **Champ d'application.**

Les plateaux et les bases du catalogue de Minio sont adaptés à un usage intérieur. L'utilisation en extérieur peut provoquer des dommages esthétiques prématurés en fonction de l'intensité de l'exposition aux agents atmosphériques et de la manière dont le plan de travail est traité après chaque cycle d'exposition à ces éléments.

1. **Scope of use.**

The table tops and bases in Minio's catalogue are suitable for indoor use. Outdoor use could cause premature aesthetic damage depending on the intensity of exposure to atmospheric agents and how the worktop is treated after each cycle of exposure to these elements.

3. **Montaje.**

El montaje de encimeras de madera se ha de realizar con herraje inoxidable o adhesivos adecuados para madera y metal.

3. **Assemblage.**

Les plateaux en bois doivent être montés à l'aide d'accessoires en acier inoxydable ou d'adhésifs adaptés au bois et au métal.

3. **Assembly.**

Wooden table tops should be mounted using stainless steel fittings or adhesives suitable for wood and metal.



2. **Recepción del pedido y almacenamiento.**

Revise el buen estado del embalaje en el momento de la recepción del pedido. Si hubiera daños o anomalías que pudieran haber afectado al material durante el transporte comuníquelo en las 24 horas siguientes a la entrega.

Si por cualquier motivo las encimeras han de permanecer almacenadas o no se pueden montar inmediatamente tras su recepción deberá tener en cuenta estos puntos:

- El almacenamiento de las encimeras se hará siempre con el material embalado y todo el herraje retirado, en posición horizontal sobre una superficie plana y firme que ofrezca un correcto apoyo a toda la superficie del paquete.
- Es necesario preservar el material en un lugar fresco y seco evitando la exposición directa a la luz solar.
- Los paquetes se pueden apilar en altura hasta un máximo de 12 encimeras. No apile encimeras de diferente forma o medida en una misma pila durante periodos largos de tiempo, esto podría provocar deformaciones en el material.

2. **Réception de la commande et stockage.**

Vérifiez que l'emballage est en bon état à la réception de la commande. En cas de dommages ou d'anomalies qui auraient pu affecter le matériel pendant le transport, signalez dans les 24 heures suivant la livraison.

Si, pour une raison quelconque, les plateaux doivent rester en stock ou ne peuvent être assemblés immédiatement après réception, vous devez tenir compte de ces points :

- Le stockage des plateaux doit toujours se faire avec le matériel emballé et tout le matériel retiré, en position horizontale sur une surface plane et ferme qui offre un support correct à toute la surface du paquet.
- Le matériel doit être stocké dans un endroit frais et sec, en évitant l'exposition à la lumière directe au soleil.
- Les paquets peuvent être empilés en hauteur jusqu'à un maximum de 12 plateaux. Ne pas empiler des plateaux de formes ou de tailles différentes dans la même pile pendant de longues périodes, car cela pourrait entraîner une déformation du matériau.



2. **Receipt of the order and storage.**

Check that the packaging is in good condition on receipt of the order. If there is any damage or anomaly that may have affected the material during transport, report it within 24 hours after delivery.

If, for any reason, the table tops have to remain in storage or cannot be assembled immediately after receipt, the following points should be taken into account:

- The storage of the table tops should always be done with the packed material and all the hardware removed, in a horizontal position on a flat and firm surface that offers a correct support to the entire surface of the package.
- The material should be stored in a cool, dry place, avoiding exposure to direct sunlight.
- The packages can be stacked in height up to a maximum of 12 table tops. Do not stack table tops of different shapes or sizes in the same pile for long periods of time, as this could cause deformation of the material.

Information

4. Utilización y mantenimiento de las encimeras y bases.

La limpieza de las encimeras y bases se realizará con un paño humedecido en agua, nunca empapado, y se secará inmediatamente después de cada limpieza.

Cuando sea necesario la superficie se limpiará con un paño suave y agua jabonosa secando seguidamente con un paño seco toda la pieza.

Para la desinfección de las encimeras se deberán utilizar desinfectantes atóxicos adecuados para el uso sobre mobiliario de madera barnizada.

El uso continuado de algunos desengrasantes domésticos puede dañar el barniz. Asegúrese de que usa productos compatibles para la limpieza de maderas tratadas.

En los casos de mesas agrupadas la limpieza se ha de realizar separando las mesas lo suficiente como para limpiar los cantos de las encimeras que quedan en contacto y secando bien estas partes antes de volver a juntarlas.

Nunca se han de apilar mesas dejando en contacto las caras superiores de las encimeras. En esta posición la humedad residual no se evapora de forma natural y puede ser absorbida por la propia encimera causando daños al material.

El uso intensivo de las encimeras puede provocar daños en la capa de barniz que protege la madera. Revise el buen estado de la superficie general de forma periódica y aplique un sellante en las zonas dañadas para evitar la entrada de humedad. Póngase en contacto con su distribuidor para recibir asesoramiento sobre el producto a aplicar más adecuado.

4. Utilisation et entretien des plateaux et bases.

Les plateaux et bases doivent être nettoyés avec un chiffon humidifié à l'eau, jamais trempé dans l'eau, et séché immédiatement après chaque nettoyage.

Si nécessaire, la surface doit être nettoyée avec un chiffon doux et de l'eau savonneuse, puis essuyée avec un chiffon sec.

Pour désinfecter les plateaux, utilisez des désinfectants non toxiques adaptés aux meubles en bois vernis.

L'utilisation continue de certains dégraissants ménagers peut endommager le vernis. Veillez à utiliser des produits compatibles pour le nettoyage du bois traité.

Dans le cas de tables groupées, le nettoyage doit être effectué en séparant les tables suffisamment pour nettoyer les bords des plateaux qui sont en contact et en séchant soigneusement ces parties avant de les remettre ensemble.

Les tables ne doivent jamais être empilées de manière à ce que les dessus des plateaux se touchent. Dans cette position, l'humidité résiduelle ne s'évapore pas naturellement et peut être absorbée par le plan de travail lui-même, ce qui endommage le matériel.

L'utilisation intensive des plateaux peut endommager la couche de vernis qui protège le bois. Vérifiez régulièrement l'état général de la surface et appliquez un produit d'étanchéité sur les zones endommagées afin d'empêcher la pénétration de l'humidité. Contactez votre revendeur pour obtenir des conseils sur le produit le plus approprié à appliquer.

4. Use and maintenance of the table tops and bases.

Table tops and bases should be cleaned with a cloth dampened in water, never soaked in water, and dried immediately after each cleaning.

When necessary, the surface should be cleaned with a soft cloth and soapy water and then wiped dry with a dry cloth.

For disinfection of Table tops, non-toxic disinfectants suitable for use on varnished wooden furniture should be used.

The continued use of some household degreasers can damage the varnish. Make sure that you use products that are compatible for cleaning treated wood.

In the case of grouped tables, cleaning should be carried out by separating the tables sufficiently to clean the edges of the Table tops that are in contact and drying these parts thoroughly before putting them back together.

Tables should never be stacked with the tops of the Table tops touching each other. In this position the residual moisture does not evaporate naturally and can be absorbed by the worktop itself, causing damage to the material.

Intensive use of the table tops can cause damage to the varnish layer that protects the wood. Check the general surface condition regularly and apply a sealant to damaged areas to prevent moisture ingress. Contact your dealer for advice on the most suitable product to apply.

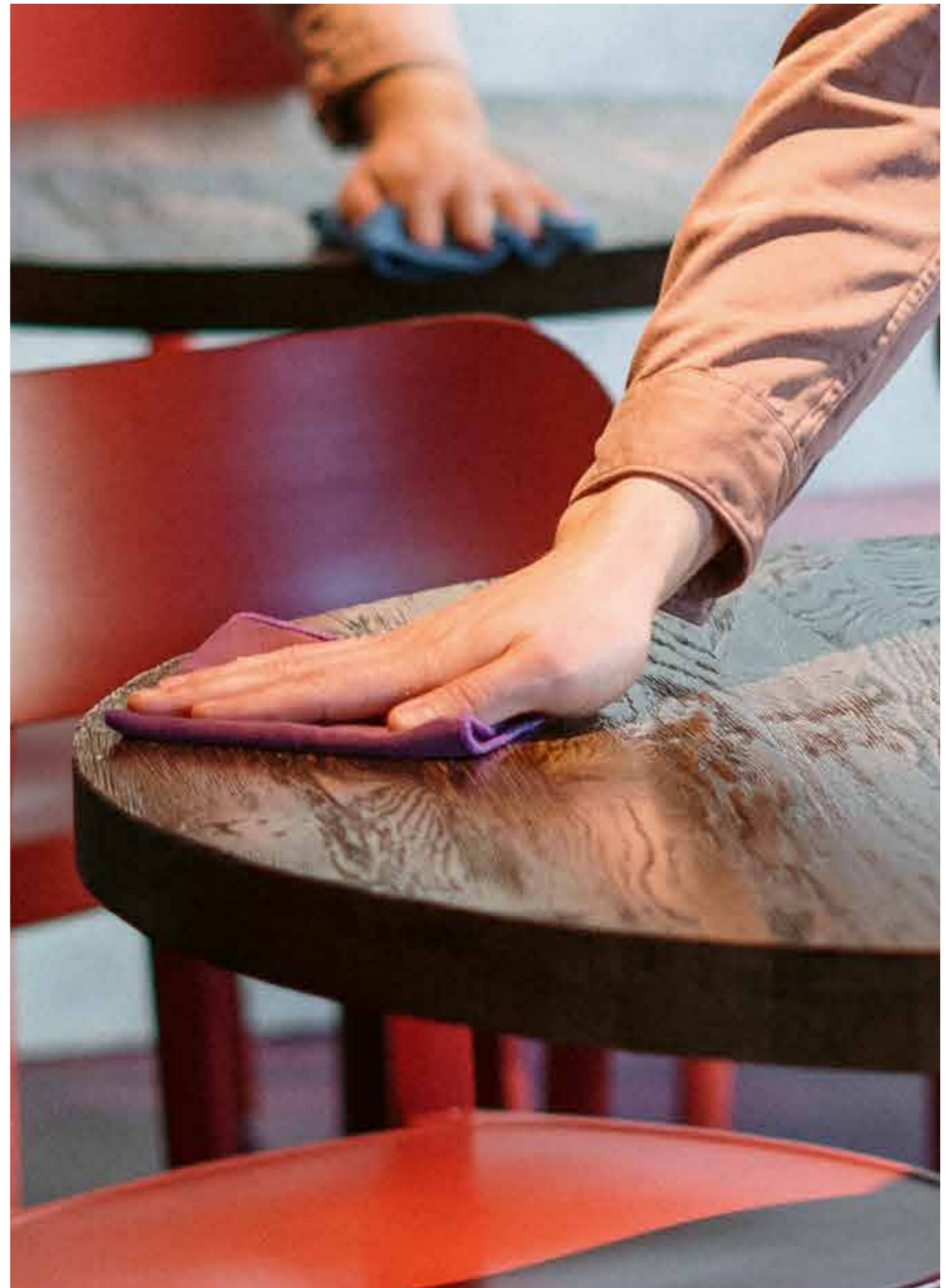

Minio Furniture is a Create Collections Brand

P.I. Pont Xetmar, C/F, núm. 8

17844 Cornellà del Terri - Girona, Spain

hello@miniofurniture.com

miniofurniture.com